



Foreign Account Tax Compliance Act

FATCA

XML
Schema
v2.0

User Guide

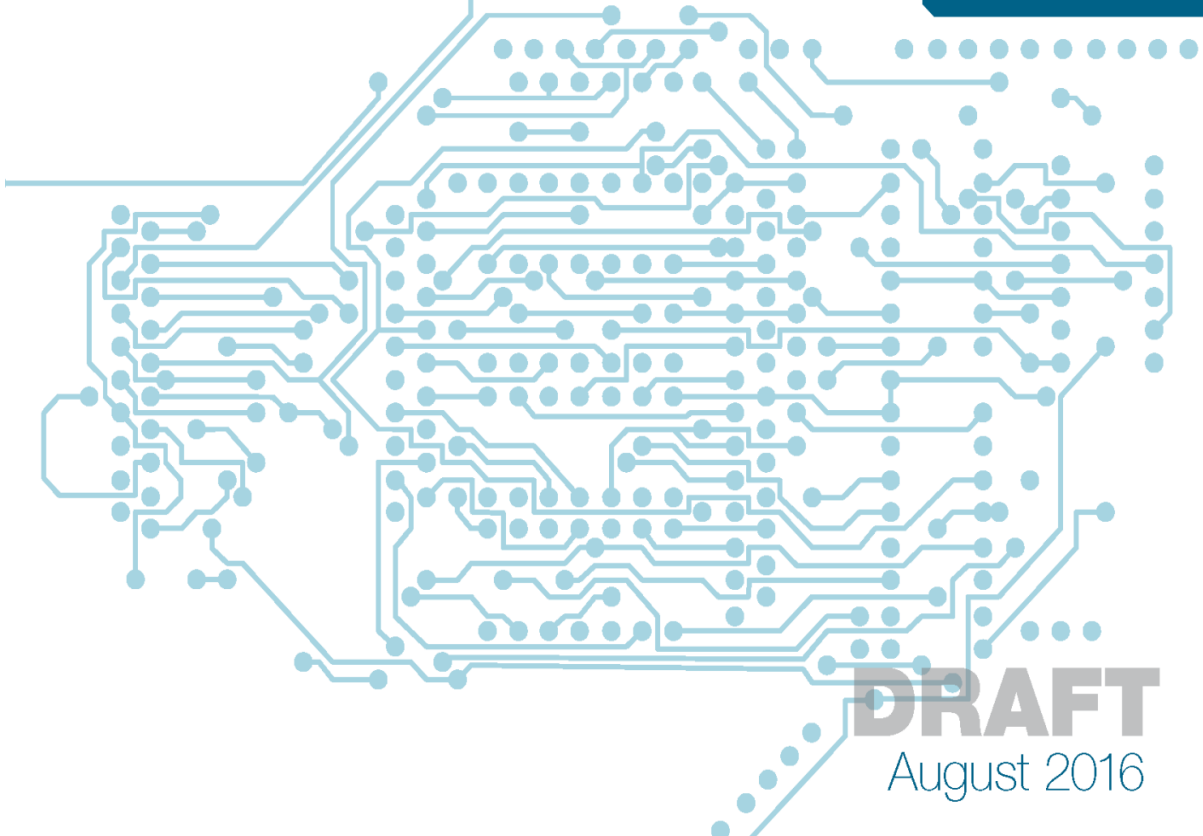

DRAFT
August 2016

Table of Contents

What's New	6
1 Introduction.....	7
1.1 About FATCA	7
1.2 Special Rules for Non-GIIN Filers.....	8
1.3 HCTA Filers.....	8
1.4 Purpose.....	9
2 FATCA XML Schema Overview.....	10
2.1 Schema Versions	12
2.2 Schema Validation	13
2.2.1 Creating New Reports using Schema v2.0	13
2.2.2 Corrected, Void and Amended Reports	14
2.3 Prohibited and Restricted Characters	14
2.4 Namespace	15
2.5 Reciprocal Exchange	16
2.5.1 Competent Authority Requests (CAR)	16
2.6 Data Preparation and Naming Conventions	16
2.7 System Testing.....	16
2.8 Other Resources	17
3 MessageSpec.....	18
3.1 SendingCompanyIN	19
3.1 TransmittingCountry.....	19
3.2 ReceivingCountry	20
3.3 MessageType.....	20
3.4 Warning	20
3.5 Contact.....	20
3.6 MessageRefId	20
3.7 CorrMessageRefId	21
3.8 ReportingPeriod	21
3.9 Timestamp.....	21
4 FATCA Report Complex Types.....	22
4.1 MonAmnt_Type	22
4.2 DocSpec_Type.....	23
4.2.1 DocTypeIndic	23
4.2.2 DocRefId	25

4.2.3	CorrMessageRefId	25
4.2.4	CorrDocRefId	26
4.3	Address_Type	26
4.3.1	CountryCode	27
4.3.2	Address Free.....	27
4.3.3	AddressFix	28
4.4	PersonParty_Type.....	29
4.4.1	ResCountryCode.....	29
4.4.2	TIN.....	30
4.4.3	Name.....	31
4.4.3.1	Titles.....	32
4.4.3.2	First Name.....	32
4.4.3.3	Middle Name	32
4.4.3.4	Last Name	33
4.4.4	Nationality.....	33
4.4.5	BirthInfo	33
4.4.5.1	BirthDate	34
4.5	OrganisationParty_Type.....	35
4.5.1	ResCountryCode.....	35
4.5.2	TIN.....	36
4.5.3	Name.....	37
4.5.4	Address	37
4.6	CorrectableReportOrganisation_Type	37
4.6.1	FilerCategory - <i>New</i>	38
4.6.2	DocSpec.....	39
5	Reporting FI.....	40
6	ReportingGroup.....	43
6.1	Sponsor	43
6.2	Intermediary	44
6.3	NilReport - <i>New</i>	45
6.3.1	DocSpec.....	46
6.3.2	NoAccountToReport.....	46
6.4	Account Report.....	47
6.4.1	DocSpec.....	48
6.4.2	AccountNumber.....	48

6.4.3	AccountClosed - <i>New</i>	49
6.4.4	AccountHolder.....	50
6.4.4.1	Individual	50
6.4.4.2	Organisation	50
6.4.4.3	AcctHolderType - <i>Updated</i>	51
6.4.5	Substantial Owner - <i>Updated</i>	52
6.4.5.1	Individual and Organization.....	52
6.4.6	AccountBalance	53
6.4.7	Payment	54
6.4.7.1	Type	55
6.4.7.2	PaymentTypeDesc - <i>New</i>	55
6.4.7.3	PaymentAmt.....	56
6.4.8	CARRef - <i>New (Model 2 IGA Reporting Only)</i>	56
6.4.8.1	PoolReportReportingFIGIIN	57
6.4.8.2	PoolReportMessageRefId	57
6.4.8.3	PoolReportDocRefId	57
6.4.9	AdditionalData - <i>New</i>	58
6.4.9.1	AdditionalItem.....	58
6.5	Pool Report	59
6.5.1	DocSpec.....	59
6.5.2	AccountCount - <i>Update</i>	59
6.5.3	AccountPoolReportType - <i>Updated</i>	60
6.5.4	PoolBalance	60
7	Correcting, Amending and Voiding Records - <i>New</i>	61
7.1	Unique MessageRefId and DocRefId	61
7.2	How to Correct, Amend or Void Records.....	62
7.2.1	Amend	63
7.2.2	Void	63
7.2.3	Correct.....	63
7.2.4	Special Cases to Amend and Correct Records	63
7.3	MessageSpec and DocSpec.....	64
Appendix A:	Glossary of Terms	66
Appendix B:	FATCA XML Schema Overview.....	69
Appendix C:	MessageSpec.....	70
Appendix D:	Reporting FI.....	71

Appendix E:	Reporting Group.....	72
Appendix F:	Account Report.....	73
Appendix G:	Pool Report	74
Appendix H:	Account Holder.....	75
Appendix I:	Substantial Owner	76
Appendix J:	Sponsor & Intermediary	77
Appendix K:	Individual or Organization Account Holders.....	78
Appendix L:	Person Party Type.....	79
Appendix M:	Address Type	80
Appendix N:	OrganisationParty_Type	81
Appendix O:	CorrectableReportOrganisationParty_Type.....	82
Appendix P:	DocSpec_Type.....	83

DRAFT

What's New

This section highlights important changes to the Foreign Account Tax Compliance Act (FATCA) XML Schema v2.0 User Guide. The schema and business rules are explained in detail throughout this publication. All changes will be effective in January 2017 and the IRS will communicate the specific transition date as soon as possible.

Future Updates

The IRS will continue to consult with partners and receive feedback to improve the guide and provide additional instructions to direct reporting NFFEs and Sponsoring Entities filing on behalf of direct reporting NFFEs.

Data Elements	Description
AccountClosed	Allows a financial institution to declare the account status as closed.
Account Holder Type	Update to the FATCA account holder type enumeration codes.
Account Number Type	Allows a financial institution to declare account number formats, such as IBAN and OSIN.
AdditionalData	Provides additional text information for an account report.
CARRef	Links account reports submitted in response to a Competent Authority Request (CAR) to the original pooled report from a financial institution from a Model 2 IGA jurisdiction. (For Model 2 reporting only)
FilerCategory	Identifies the filer category code for a reporting financial institution and/or sponsor.
NilReport	Indicates a reporting financial institution has no accounts to report.
Payment Type Description	Provides text description for payment types.
Substantial Owner	Allows a filer to name a substantial owner as an entity or organization.

1 Introduction

1.1 About FATCA

The Foreign Account Tax Compliance Act (FATCA) was enacted as part of the Hire Incentives to Restore Employment (HIRE) Act in 2010. FATCA was created to address non-reporting of income related to foreign financial accounts held by US taxpayers. FATCA requires certain foreign financial institutions (FFIs) to report certain information about its U.S. accounts, accounts held by owner-documented FFIs (ODFFI), and certain aggregate information concerning accounts held by recalcitrant account holders and, for 2015 and 2016, accounts held by nonparticipating FFIs. Generally, FFIs will commit to this reporting requirement by registering with the IRS and signing an agreement with the IRS.

The FATCA regulations also require a withholding agent to deduct and withhold tax equal to 30 percent of a withholdable payment made to a passive non-financial foreign entity (NFFE) unless the passive NFFE certifies to the withholding agent that it does not have any substantial U.S. owners or provides certain identifying information with respect to its substantial U.S. owners. A withholding agent is also required to report information about substantial U.S. owners of a passive NFFE and specified U.S. persons holding certain equity or debt interests in a payee that the withholding agent has agreed to treat as an ODFFI. Payments to NFFEs that report their substantial U.S. owners (or report that they have no substantial U.S. owners) directly to the IRS (direct reporting NFFEs) are excepted from withholding and reporting by a withholding agent or an FFI.

To facilitate FATCA implementation for FIs operating in jurisdictions with laws that prevent the FIs from complying with the terms of the FFI agreement, the Treasury Department developed two alternative model intergovernmental agreements (IGAs) (Model 1 IGA and Model 2 IGA) that allow FIs operating in such jurisdictions to perform due diligence and reporting on their account holders to achieve the objectives of FATCA. FFIs reporting under a Model 1 IGA (reporting Model 1 FFIs) report certain information about their U.S. reportable accounts and certain payees as required under the applicable IGA to their respective tax authorities. Reporting Model 1 FFIs do not report directly to the IRS. However, certain reporting Model 1 FFIs in a “Model 1 Option 2” jurisdiction may use the schema to report to their tax authorities. FFIs reporting under a Model 2 IGA (Reporting Model 2 FFIs) report directly to the IRS certain information about their U.S. accounts, and certain aggregate information concerning account holders who do not waive legal restrictions for the FFI to report this information (non-consenting U.S. accounts), and, for 2015 and 2016, certain payments made to accounts held by nonparticipating FFIs as required under the applicable IGA and the regulations.

Trustee-Documented Trusts subject to a Model 2 IGA are reported by the trustee of the Trustee-Documented Trust. A Sponsoring Entity reports on accounts of FFIs that it has agreed to treat as Sponsored FFIs or substantial U.S. owners of passive NFFEs that it has agreed to treat as Sponsored Direct Reporting NFFEs.

For the latest information about legislative and tax law topics covered in this publication, go to www.irs.gov/FATCA.

1.2 Special Rules for Non-GIIN Filers

An approved financial institution (FI) (other than a limited FFI or a limited branch), direct reporting NFFE, or sponsoring entity that registers with the IRS under FATCA will receive a global intermediary identification number (GIIN). There are certain entities that are permitted to use IDES to file on behalf of others that may not register to obtain a GIIN (non-GIIN filers) such as:

- U.S. withholding agents (USWA)
- Territory financial institutions (TFI) treated as U.S. persons
- Third party preparers
- Commercial software vendors

A non-GIIN filer must obtain a FATCA Identification Number (FIN) in order to enroll in the International Data Exchange Service (IDES) for FATCA reporting.

The GIIN and FIN appear on the FFI list published by the IRS on the first day of each month. Publication of a FIN on the FFI list does not change the filer's status for FATCA purposes, as it does not make the filer an FFI and does not serve any function related to withholding tax on payments under FATCA. A FIN will be accompanied by a generic name (e.g., "U.S. Withholding Agents 1") on the FFI list. For more information on FINs, go to the FATCA Identification Number (FIN) enrollment page at <https://www.irs.gov/businesses/corporations/finenrollment-process>.

1.3 HCTA Filers

The HCTA of a Model 1 IGA jurisdiction uses the schema to report to the IRS certain information on U.S. Reportable Accounts (as defined in the applicable IGA) of reporting Model 1 FFIs covered by the IGA and, for 2015 and 2016, information with respect to nonparticipating FFIs that receive payments from reporting Model 1 FFIs.

If a Model 1 IGA jurisdiction has elected to allow reporting Model 1 FFIs in its jurisdiction to use IDES to report to the IRS ("Model 1 Option 2"), the reporting Model 1 FFI transmits data directly to its HCTA using the schema. The HCTA approves or rejects the reports; if approved, the HCTA releases the data to the IRS.

1.4 Purpose

The FATCA XML Schema v2.0 User Guide (Publication 5124) outlines the business and validation rules to support a Form 8966, FATCA Report transmitted electronically through the International Data Exchange Service (IDES). All IDES users should be familiar with FATCA regulations, Extensible Markup Language (XML) and the FATCA XML schemas. These guidelines should be used in conjunction with the most current version of other FATCA resources and are available on www.irs.gov:

FATCA Online Registration:

▪ Publication 5118	FATCA Online Registration User Guide Provides instructions to complete the online FATCA Online Registration System or electronic Form 8957, FATCA Registration
▪ Publication 5147	FFI List Search and Download Tool User Guide Provides instructions on how to use the FFI List Search and Download Tool to search for approved GIINs and FINs

FATCA Reporting (IDES, data preparation, transmission and messaging):

▪ Publication 5190	FATCA IDES User Guide Provides instructions on how to use the International Data Exchange Service to transmit FATCA reporting data
▪ Publication 5188	FATCA Metadata XML Schema v1.1 User Guide Explains the XML schema and data elements used in the FATCA metadata file
▪ Publication 5189	International Compliance Management Model (ICMM) User Guide Explains the schema and business rules of a FATCA notification
▪ Publication 5216	International Compliance Management Model (ICMM) Notification XML Schema Explains the XML schema and data elements of a FATCA notification
▪ Form 8966	Form 8966, FATCA Report and form instructions.

Data Security:

▪ Publication 4557	Safeguarding Taxpayer Data: A Guide for Your Business Provides information on legal requirements to safeguard taxpayer data
▪ Publication 4600	Safeguarding Taxpayer Information Quick Reference Guide for Businesses Provides information on data safeguard techniques and how to report data security incidents

Table 1 – FATCA related resources

2 FATCA XML Schema Overview

The FATCA XML schema governs the structure and content of files that define the electronic format for Form 8966, FATCA Report. It is used to create reports that conform to recommended standards and provide first level schema validation. The FATCA XML schema is based on an existing reporting schema and business requirements used by the Organisation for Economic Co-operation and Development (OECD) and the European Union (EU).

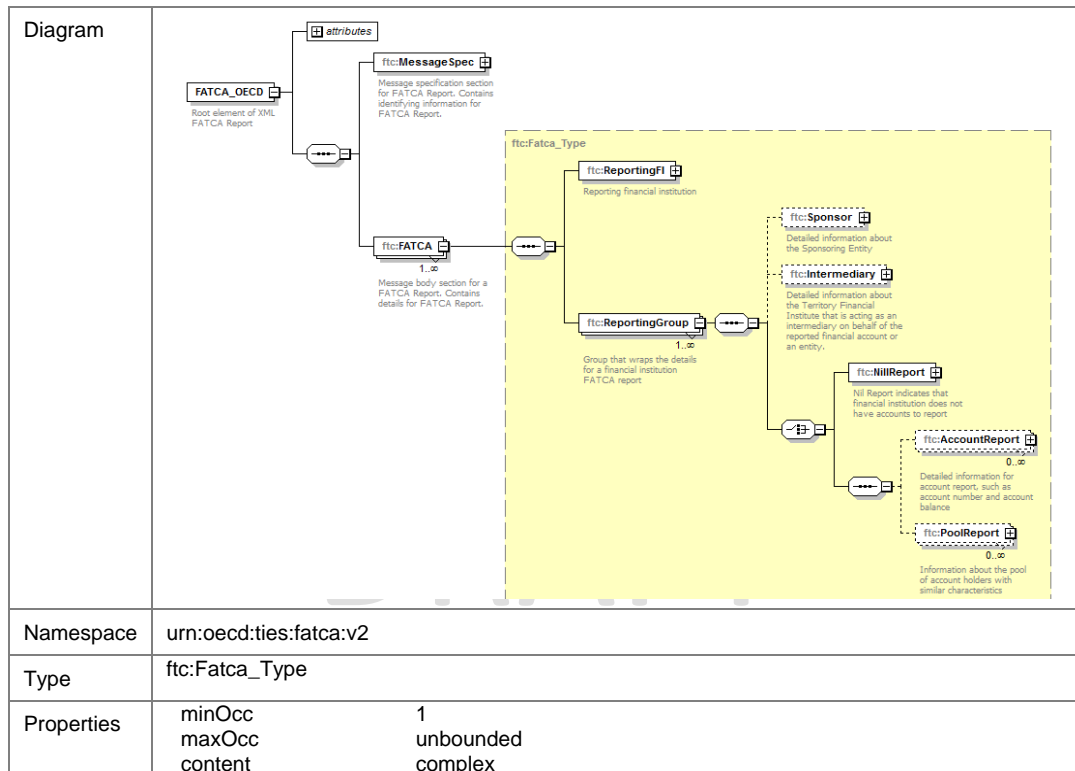

Table 2 – FATCA XML schema overview

The FATCA XML schema v2.0 takes precedence over any information presented in the guide. All schema and sample files can be viewed with an XML tool, such as XML Notepad. For more information on the schema library structure, samples and other resources, go to <https://www.irs.gov/Businesses/Corporations/FATCA-XML-Schemas-and-Business-Rules-for-Form-8966>.

General terms in the schema are described by the definition, attribute, and constraints as listed below:

Items	Description
Attribute	<ul style="list-style-type: none"> ▪ An attribute describes additional data related to a specific element. If blank, then there are no associated attributes.
Cardinality	<ul style="list-style-type: none"> ▪ The number of times an element occurs in an XML file. ▪ The ability to repeat information within the schema is the electronic equivalent of attaching additional forms when there is insufficient space on the form to include all of the information that must be filed. ▪ If cardinality is not defined, then one and only one instance should be included (minOccurs=1 and maxOccurs=1). ▪ Where a data element is not used, then the associated attribute(s) are not used.
Data Type	<ul style="list-style-type: none"> ▪ The data type or classification of a data element value, such as numeric, string, Boolean, or time. ▪ XML supports custom data types and inheritance.
Element	<ul style="list-style-type: none"> ▪ XML data elements defined in the FATCA XML schema; elements not described in the guide are not supported in the schema.
Encoding	<ul style="list-style-type: none"> ▪ The UTF-8 encoding standard must be used in all XML messages. FATCA XML schema does not support other encoding schemes, such as UTF-16 and UTF-32. ▪ The Latin (extended) character set commonly used in international communication should be used.
Message	<ul style="list-style-type: none"> ▪ The term message refers to an XML instance based on the FATCA XML schema.
Namespace/Prefix	<ul style="list-style-type: none"> ▪ XML namespaces provide a simple method for qualifying element and attribute names used in XML documents by associating it with namespaces identified by URI references. ▪ A prefix is associated with a namespace in namespace declaration. It can be used to qualify element s and/or attributes defined under the namespace. For more information, go to Section 2.4.Namespace.
Requirement:	<ul style="list-style-type: none"> ▪ The requirement column indicates whether the element is required at the schema level or application level and must be included in the XML file.
Size/Pattern	<ul style="list-style-type: none"> ▪ The minimum and/or maximum character size of the element value. ▪ If size is not defined, assume a limitation default of 200 characters.

Terms used throughout this guide:

Description	<ul style="list-style-type: none"> ▪ The definitions for the message set or element.
Choice	<ul style="list-style-type: none"> ▪ The choice element allows only one of the elements in the <choice> declaration to be present within the containing element. ▪ In the schema requirement column, “Choice” indicates the element as one of the options that can be selected when creating an XML file.
File	<ul style="list-style-type: none"> ▪ A file is a collection of reports transmitted to the receiving jurisdiction. A file may contain one or many records.
Mandatory	<ul style="list-style-type: none"> ▪ The data element is not used for schema validation but is mandatory for FATCA reporting. ▪ The data element will pass schema validation, but will fail application level validation if not present.
Null	<ul style="list-style-type: none"> ▪ The data element is not used for FATCA reporting and may be omitted.
Optional	<ul style="list-style-type: none"> ▪ The data element is not required for schema validation or FATCA reporting but may be provided if available. ▪ The use of an optional field may be subject to an intergovernmental agreement (IGA), and in some scenarios, may be mandatory for application level validation. For more information consult your local tax authority.
Record	<ul style="list-style-type: none"> ▪ A single Nil Report, Account Report or Pool Report is equivalent to one paper Form 8966. A record includes information on the ReportingFI, Sponsor or Intermediary (if any), “No accounts to report” statement in a Nil Report or the account data in an AccountReport or PoolReport element.
Report	<ul style="list-style-type: none"> ▪ A group of records assembled into a single XML instance may contain one or many records.
Required	<ul style="list-style-type: none"> ▪ The data element is required for schema validation and must be included in the XML file; if not included the file will fail schema validation. ▪ A requirement may be enforced on the schema and/or application level.

Table 3 – FATCA schema terms and descriptions

2.1 Schema Versions

The version of the schema and the corresponding business rules have a unique version number assigned that consists of two numbers separated by a period sign: major and minor version. The version is identified by the version attribute on the schema element. The target namespace of the FATCA schema contains only the major version.

```

- <xsd:schema targetNamespace="urn:oe.cd:ties:fatca:v2" elementFormDefault="qualified" attributeFormDefault="unqualified" version="2.0">
  <xsd:import namespace="urn:oe.cd:ties:isofatcatypes:v1" schemaLocation="isofatcatypes_v1.1.xsd"/>
  <xsd:import namespace="urn:oe.cd:ties:stffatcatypes:v2" schemaLocation="stffatcatypes_v2.0.xsd"/>
  <xsd:import namespace="urn:oe.cd:ties:stf:v4" schemaLocation="oe.cdtypes_v4.1.xsd"/>

```

Figure 1 – Schema namespaces

The root element FATCA_OECD version attribute in the XML report file must be set to the value of the schema version. This will identify the schema version that was used to create the report.

Element	Attribute	Size	Data Type	Schema Requirement	Application Requirement
FATCA_OECD	version	Max 10	sfa:StringMax10_Type	Required	

It is important to note the following principles regarding schema version numbers:

- In general, there is one schema version to support FATCA reporting for the current and previous tax years. There are certain FATCA Reports that may be composed using previously published schema versions but the IRS will only validate against the current schema version 2.0.
- The version attribute on the root element in the schema is not fixed and allows you to create a report with a lower compatible version that will be validated with the current schema.

Note: If there are critical changes required due to late changes to legal requirements, national disasters, or errors identified during testing or production, the IRS may issue minor updates to the business rules during the processing year.

2.2 Schema Validation

Schema validation and business rule processing (application level validation or record level validation) occurs after a filer successfully submits a data packet or transmission using IDES. All data files should be validated prior to transmission to identify potential error conditions.

2.2.1 Creating New Reports using Schema v2.0

The XML schema version 2.0 will support FATCA reporting for the current and all previous tax years. The schema version 2.0 is generally not backward compatible with schema version 1.1.

Important: The IRS strongly recommends that filers use schema v2.0 (or later versions) for FATCA reporting. A data file formatted using schema v1.1 may validate against schema v2.0; however, there are numerous new optional elements (e.g., FilerCategory element presence and values) and field-level reporting requirements that will likely cause record-level errors for files validated using schema v1.1.

2.2.2 Corrected, Void and Amended Reports

Data files created with schema v1.1 can be corrected, voided or amended using schema v2.0. Pool Reports should not be included in FATCA Report if the pool contains zero accounts. Any file with an empty pool report will not be validated against schema v2.0. If a Pool report with zero accounts was previously included in error, the IRS will not require you to void the report. In case additional accounts for the pool report are discovered later, a new Pool report can be submitted.

2.3 Prohibited and Restricted Characters

All XML data files should conform to recommended XML schema best practices. Certain special characters and patterns are prohibited and if included will cause the file to reject the transmission and generate an error notification.

Non-Optional Entity Reference

If an XML document contains one of these characters in the XML text content, the data packet will be rejected and generate an error notification (XML not well-formed). The characters are not allowed by XML syntax rules and must be replaced with the following predefined entity references. To prevent error notifications, do not include any of these characters in the XML documents.

Characters	Descriptions	Character Allowed	Allowed Entity Reference
&	Ampersand	Rejected	&
<	Less Than	Rejected	<

Table 4 - Non-Optional entity references

Optional Entity Reference

If an XML document contains one of these characters in the XML text content, the use is not restricted by XML syntax rules. The characters can be replaced by the following predefined entity references to conform to XML schema best practices.

Characters	Descriptions	Character Allowed	Replace Entity Reference
>	Greater Than	Allowed	>
'	Apostrophe*	Allowed	'
"	Quotation Mark	Allowed	"

Table 5 - Optional entity reference

Note: In all cases, additional pattern matching may be performed on special characters that are directly followed by a known SQL command and the combination will trigger threat detection and a file level error notification.

SQL Injection Validation

If an XML document contains one of the following combinations of characters in the XML text content, the data packet will be rejected and generate a failed threat detection error notification. To prevent error notifications, do not include any of the combinations of characters.

Characters	Descriptions	Entity Reference
--	Doubled Dash	N/A
/*	Slash Asterisk	N/A
&#	Ampersand Hash	N/A

Table 6 - SQL injection validation

DocRefId and MessageRefId Character Sets

The StringMax200_Type data type is used to define several data elements, such as MessageRefId, CorrMessageRefId, DocRefId, and CorrDocRefId. A value with a character string not exceeding 200 characters will validate against the schema v2.0. However, the IRS strongly recommends that all characters in these elements conform to the following:

- Upper or lower case letters (“a-z”, “A-Z”)
- Numerals (“0-9”)
- Special characters including plus (“+”), underscore (“_”), hyphen/dash (“-”), and period (“.”).

2.4 Namespace

The FATCA XML schema v2.0 uses namespaces based on OECD common reporting standards. The following namespaces are defined:

Prefix	Namespace	Description
sfa	xmlns:sfa="urn:oe.cd:ties:stffatcatypes:v2	Referenced by the main schema. Defines common data types specific for FATCA based on OECD Standard Transmission Format (STF).
ftc	xmlns:ftc="urn:oe.cd:ties:fatca:v2	Target FATCA namespace that contains FATCA data types and data elements.
iso	xmlns:iso="urn:oe.cd:ties:isofatcatypes:v1	Referenced by the main schema and provides country codes defined in ISO 3166-1 and ISO 4217 standards.
stf	xmlns:stf="urn:oe.cd:ties:stf:v4	Contains OECD STF data types.

Table 7 - Namespace and prefix list

2.5 Reciprocal Exchange

The IRS will participate in exchange of information with certain foreign tax administrations under a bilateral Model 1 IGA. The reciprocal report schema format, encryption method and data preparation are the same procedures used for FATCA reporting transmission during the applicable tax year. For additional information, refer to your U.S. Competent Authority Agreement.

2.5.1 Competent Authority Requests (CAR)

The IRS may send U.S. Competent Authority requests to Model 2 HCTAs in response to pooled reports from reporting Model 2 FFIs on non-consenting U.S. accounts and nonparticipating FFIs. An HCTA that receives a U.S. Competent Authority request through IDES should use the schema to send the requested information to the IRS.

2.6 Data Preparation and Naming Conventions

There are specific data preparation guidelines on how to structure and package data files. Filers are responsible for completing the FATCA XML file as specified by FATCA regulations, IRS forms and applicable IGAs. During the data preparation process, you should provide information that conforms to the current schema while also complying by applicable business rules. All recommended file names are case sensitive and any variation in encryption method, name, extension or format may cause a transmission failure. For more information on IDES, go to [Publication 5190. The IDES User Guide](#). There are several online resources to help you prepare and submit a valid FATCA XML document:

Description	Location
<ul style="list-style-type: none">Data preparation software sample code<ul style="list-style-type: none">.NETJavaOpenSSLUNIX	https://github.com/IRSGov
<ul style="list-style-type: none">IDES data preparation summary and sample files	https://www.irs.gov/Businesses/Corporations/IDES-Data-Transmission-and-File-Preparation

Table 8 - IDES data preparation resources

2.7 System Testing

Each year the IRS reviews any new FATCA legal requirements and improvements to assess the impact on IRS forms and processing procedures. These changes determine updates to the XML schemas and business rules. IRS notifies all users of schema changes in the testing and production environments.

All enrolled users are eligible to participate during testing. All filers must enroll in IDES with a valid IRS-issued GIIN, FIN or HCTA Entity ID/username, and a valid certificate. Filers are strongly encouraged to

update their software and to test any schema changes. The test environment configurations may not be identical to the production system. For more information, go to <https://www.irs.gov/Businesses/Corporations/IDES-Testing-Schedule>.

2.8 Other Resources

The FATCA Global IT Forum provides monthly updates on major developments. Technical experts are available to your answer questions and discuss various topics. The IRS distributes information to FATCA partners through the *FATCA Newsletter*. Subscribers receive communications regarding known issues, processing delays and early notification of upcoming testing sessions. Sign up on the subscription page at <https://www.irs.gov/individuals/international-taxpayers/subscribe-to-the-fatca-news-and-information-list>.

For assistance with transmission error notifications, go to the instructions contained in the notification or visit <https://www.irs.gov/businesses/corporations/irs-fatca-report-notifications>. You may also provide feedback on the quality of this publication and submit comments through the [IDES FAQ webpage](#).

DRAFT

3 MessageSpec

The MessageSpec identifies the financial institution (FI), host country tax authority (TA or HCTA) and non-GIIN filers sending a message. It contains unique message identifiers, references corrected messages and specifies the date created, calendar year and reporting period.

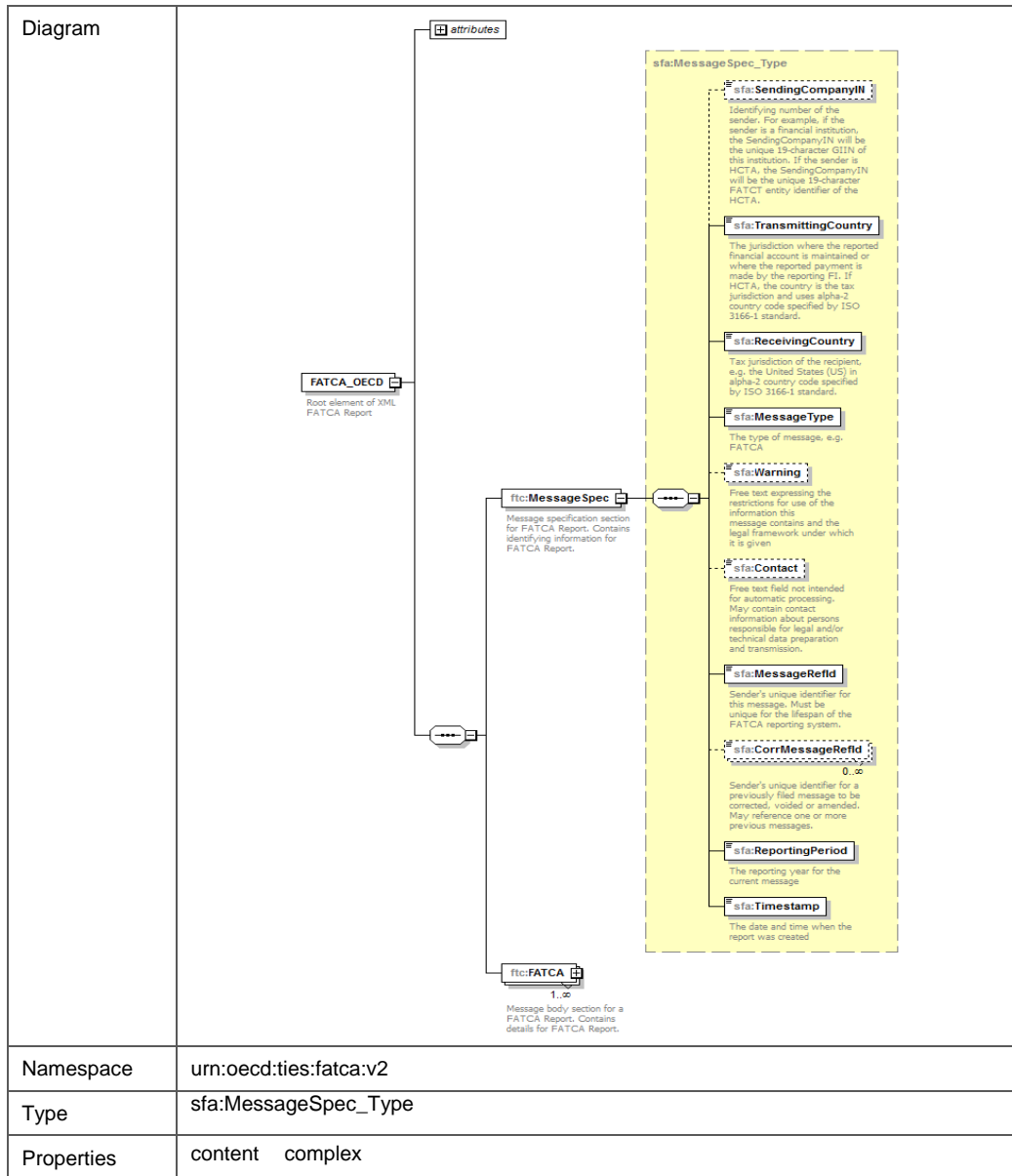

Table 9 – MessageSpec

3.1 SendingCompanyIN

Element	Attribute	Size	Data Type	Schema Requirement	Application Requirement
SendingCompanyIN		19-characters GIIN format	sfa:StringMax200_Type	Optional	Mandatory

This data element identifies the sender's 19-character identifying number.

- If the sender is an FI, Sponsoring Entity or direct reporting NFFE, enter the assigned GIIN with appropriate punctuation (period or decimal). The field is mandatory and the report will not be accepted without a valid IRS-approved GIIN. Example: 98Q96B.00000.LE.250
- If the sender is an HCTA, enter the HCTA FATCA Entity ID in GIIN format. Example: 000000.00000.TA.250.
- If the sender is a non-GIIN filer, enter the FATCA Identification Number (FIN). The FIN is entered in the message header for filing purposes only. Do not use a FIN under FATCA data elements in the body of the report.

3.1 TransmittingCountry

Element	Attribute	Size	Data Type	Schema Requirement	Application Requirement
TransmittingCountry		2 characters	iso:CountryCode_Type	Required	

This data element identifies the tax jurisdiction as a 2-character alphabetic country code specified in the ISO 3166-1 Alpha 2 standard. Example: MX (Mexico) or Germany (DE).

- If the sender is a HCTA, enter the country code for the jurisdiction of the tax authority.
- If the sender is an FI, enter the country code for the jurisdiction where the reporting FI maintained the reportable financial accounts. Example: The sender is an FI established in Jurisdiction A and operates branches in Jurisdiction B. The reported financial accounts are maintained by the FI at its branch in Jurisdiction B. The TransmittingCountry is Jurisdiction B, the jurisdiction where the FI maintains the reported account.
- If the sender is a direct reporting NFFE, enter the country code for the jurisdiction of residence of the NFFE.
- If the sender is a Sponsoring Entity, enter the country code for the jurisdiction where the Sponsored FFI maintains the account or the jurisdiction where the Sponsored Direct Reporting NFFE is resident.
- If the sender is a withholding agent, enter the country code for the jurisdiction of residence of the payer.

3.2 ReceivingCountry

Element	Attribute	Size	Data Type	Schema Requirement	Application Requirement
ReceivingCountry		2 characters	iso:CountryCode_Type	Required	

This data element identifies the jurisdiction of the receiving entities' tax administration (TA) and uses the 2-character alphabetic country code specified in the ISO 3166-1 Alpha 2 standard. Example: When you send a FATCA Report to the IRS, the receiving country will always be "US" (United States).

3.3 MessageType

Element	Attribute	Size	Data Type	Schema Requirement	Application Requirement
MessageType		5 characters	sfa:MessageType_EnumType	Required	

This data element specifies contents of the message type. The element is an enumeration and the only value is "FATCA".

3.4 Warning

Element	Attribute	Size	Data Type	Schema Requirement	Application Requirement
Warning		Max 4000	sfa:StringMax4000_Type	Optional	

This data element is a free text field for input of specific cautionary instructions about use of the message content. The field is not required for FATCA reporting and may be omitted.

3.5 Contact

Element	Attribute	Size	Data Type	Schema Requirement	Application Requirement
Contact		Max 200	sfa:StringMax200_Type	Optional	Null

This data element is a free text field for input of specific contact information for the sender. The field is not used for FATCA reporting and may be omitted.

3.6 MessageRefId

Element	Attribute	Size	Data Type	Schema Requirement	Application Requirement
MessageRefId		Max 200	sfa:StringMax200_Type	Required	

This data element is a free text field to capture the unique identifier number for the sender's message. It allows both the sender and receiver to identify and correlate a specific message. The MessageRefId is created by the sender and must be unique across all FATCA XML files received from the entity identified

in the SendingCompanyIN element. The IRS strongly recommends using a Globally Unique Identifier (GUID) to help ensure uniqueness of assigned MessageRefId values.

3.7 CorrMessageRefId

Element	Attribute	Size	Data Type	Schema Requirement	Application Requirement
CorrMessageRefId		Max 200	sfa:StringMax200_Type	Optional	

This data element is a free text field to capture the unique identifier of a previously filed report. It is used to reference the original message when sending a corrected, amended or voided report. It allows the sender and the receiver to identify and correlate a specific message.

When revising a file, it must reference the previous MessageRefId created for the previous message. MessageSpec can contain multiple CorrMessageRefId elements. If the file contains corrections for records from multiple previous files, include the CorMessageRefId element for each original file. Files with new data (FATCA1) should not contain CorrMessageRefId element. For more information, go to [Section 7. Correcting, Amending or Voiding Records](#).

3.8 ReportingPeriod

Element	Attribute	Size	Data Type	Schema Requirement	Application Requirement
ReportingPeriod			xsd:date	Required	

This data element identifies the reporting year for the current message in YYYY-MM-DD format. Do not enter future years. Example: If reporting information for accounts or payments made in 2016, enter value as "2016-12-31".

3.9 Timestamp

Element	Attribute	Size	Data Type	Schema Requirement	Application Requirement
Timestamp			xsd:dateTime	Required	

This data element identifies the date and time the message was created and may be automatically populated by the host system. The format is YYYY-MM-DD'T'hh:mm:ss and fractions of seconds are not used. Example: 2015-03-15T09:45:30.

4 FATCA Report Complex Types

FATCA complex types are used to define the content of different elements and attributes in several structures. The data integrity components and schema validation are the same; however, different business rules or application requirements may apply based on the filing scenario. These complex types are also described in other parts of the schema.

4.1 MonAmnt_Type

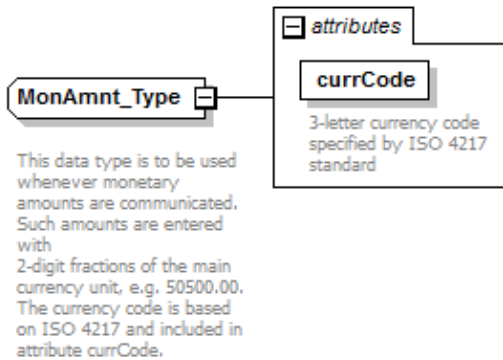

Figure 2 - MonAmnt_Type element

Data Type	Attribute	Size	Data Type	Schema Requirement	Application Requirement
MonAmnt_Type			sfa:TwoDigFract_Type	Required	
MonAmnt_Type	currCode		iso:currCode_Type	Required	

This data type is used to report payments and balances. It allows 2-digit fractional amount in the reported currency. All amounts must use the currCode attribute, valid three-character ISO 4217 currency code. If the amounts are not reported in U.S. dollars, enter the code for the reported currency. For amounts in dollars use the “USD” currency code. For example, fifty-thousand US dollars should be entered as “50000.00” or “50000 with “USD” currency code attribute.

4.2 DocSpec_Type

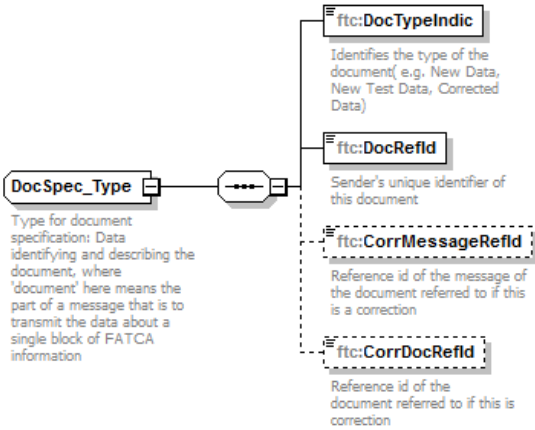

Figure 3 - DocSpec_Type

Element	Attribute	Size	Data Type	Schema Requirement	Application Requirement
DocSpec			ftc:DocSpec_Type	Required	

DocSpec_Type is the complex datatype for the DocSpec element. It uniquely identifies the data element, the type of data, references the record being corrected, amended or voided and associates each record to a report. The element allows you to manage record level error handling on previously filed reports and update a specific part of a record without resending an entire report.

The DocSpec element is included in all correctable elements, such as CorrectableAccountReport and CorrectableNilReport. For more information on how to correct, amend or void a record, go to [Section 7.2. How to Amend, Correct and Void a Record](#).

Note: A record consists of data on the ReportingFI, Sponsor or Intermediary (if any), plus the account information from a NilReport or AccountReport or PoolReport.

4.2.1 DocTypeIndic

Element	Attribute	Size	Data Type	Schema Requirement	Application Requirement
DocTypeIndic			ftc:FatcaDocTypeIndic_EnumType	Required	

This data element specifies the type of data being submitted, such as new data or test data. As a best practice, a message should contain only one DocTypeIndic in a single transmission. Do not combine new, corrected, void and amended records or any combination within the same message. As a best practice, send a separate XML file for each type of data.

Application Requirement: The DocTypeIndic codes FATCA11-14 must only be used during testing periods in the testing environment and must not be used for FATCA reporting to the production environment. The IRS will notify all users of open testing sessions. **Failure to adhere to this restriction will result in a file level error notification.** For more information on testing, go to [Section 2.7 System Testing](#).

DocTypeIndic	Data Type Description
--------------	-----------------------

Production Environment – Use FATCA 1, 2, 3 or 4

FATCA1	New Data	Indicates new records sent to the IRS that has not been previously processed or voided.
FATCA2	Corrected Data	Indicates corrected records re-transmitted after the sender received a record level error notification. Use FATCA2 in response to a record-level error notification to correct data. It is not used in response to file-level errors (Notifications N1 through N4).
FATCA3	Void Data	Indicates previously filed records that should be voided. All fields in a voided record must match or have the same values as the original record. Use FATCA3 to void the original transmission. As a best practice to manage error handling, the following record-level error notifications require the sender to (1) void the original record as FATCA3 and then (2) submit new data as FATCA1: <ul style="list-style-type: none"> ▪ No TIN of Account Holder or Substantial US Owner ▪ Incorrect TIN of Account Holder or Substantial US Owner ▪ Incorrect Name of Account Holder or Substantial US Owner ▪ Incorrect Name and Address for Account Holder or Substantial US Owner In addition, certain IGA jurisdictions require the following errors to be voided: <ul style="list-style-type: none"> ▪ No TIN or Date of Birth of Individual Account Holder or Substantial US Owner. ▪ No TIN and Incorrect Date of Birth Individual Account Holder or Substantial US Owner ▪ See Section 4.4.5 BirthInfo.
FATCA4	Amended Data	Indicates previously filed records contained errors that should be replaced or amended. Use FATCA4 if you determine a record that you previously filed needs to be updated. Do not use in response to an error notification.

Testing Environment – Use FATCA 11,12,13 or 14

FATCA11	New Test	Similar to FATCA1 and indicates test data.
FATCA12	Corrected Test	Similar to FATCA2 and indicates test data.
FATCA13	Void Test	Similar to FATCA3 and indicates test data.
FATCA14	Amended Test	Similar to FATCA4 and indicates test data.

Table 10 - DocTypeIndic enumerated codes

4.2.2 DocRefId

Element	Attribute	Size	Data Type	Schema Requirement	Application Requirement
DocRefId		Min 21 characters Max 200 characters	sfa:StringMax200_Type	Required	

This data element is an identifier for a specific record and must be unique across all reporting systems and reporting periods. A unique DocRefId must be generated for each Nil Report or Account Report or Pool Report and each Reporting FI, Sponsor and Intermediary (if any). The DocRefId cannot be reused within the scope of FATCA reporting. A message with an invalid or duplicate DocRefId will cause an error notification. For more information on how to enter a TIN in GIIN format, go to [Section 4.4.2 PersonParty_Type TIN](#) or [Section 4.5.2 OrganisationParty_Type TIN](#).

DocRefId Format

The DocRefId data element must conform to recommended best practices for file format and contain a minimum of 21 characters that include:

- Reporting FI GIIN: The GIIN for the reporting FI associated with the reporting group. Some filers may use a TIN in GIIN format and include an additional zero, such as 123456.78900.SL.840.
- Period character: (.)
- Unique Value: The value for the referenced record that is unique within the reporting FI for all time.
- Recommended globally unique identifier (GUID).

Example: S519K4.99999.SL.392.12291cc2-37cb-42a9-ad74-06bb5746b60b

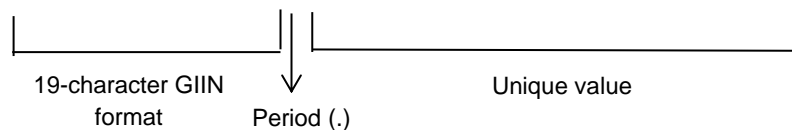

4.2.3 CorrMessageRefId

Element	Attribute	Size	Data Type	Schema Requirement	Application Requirement
CorrMessageRefId		Min 1 char	sfa:StringMin1Max200_Type	Optional	

This data element identifies a message that contained a record to be voided, amended or corrected. It references the MessageRefId from a previously filed report and ensures the proper records are updated. The value must match the MessageRefId from the MessageSpec element. The CorrMessageRefId element is used in combination with DocTypeIndic codes, FATCA2, FATCA3 or FATCA4 (or FATCA12, FATCA13, FATCA14, if test data). Note: Do not use CorrMessageRefId when submitting new data (FATCA1).

4.2.4 CorrDocRefId

Element	Attribute	Size	Data Type	Schema Requirement	Application Requirement
CorrDocRefID		Min 1 char	sfa: StringMin1Max200_Type	Optional	

This data element identifies a record to be voided, amended or corrected. It references the DocRefId from a previously filed report and ensures the proper records are updated. The value must match the DocRefId. The CorrDocRefId element is used in combination with DocTypeIndic codes, FATCA2, FATCA3 or FATCA4 (or FATCA12, FATCA13, FATCA14, if test data). Note: Do not use CorrDocRefId when submitting new data (FATCA1).

4.3 Address_Type

The Address_Type allows free text input of the address for any individual or organization included in the report (e.g., reporting FI, account holder, substantial owner). There are two available options, AddressFree or AddressFix with supplemental optional AddressFree.

AddressFix should be used for all FATCA reporting; however, you may select AddressFree to enter the data in a less structured format.

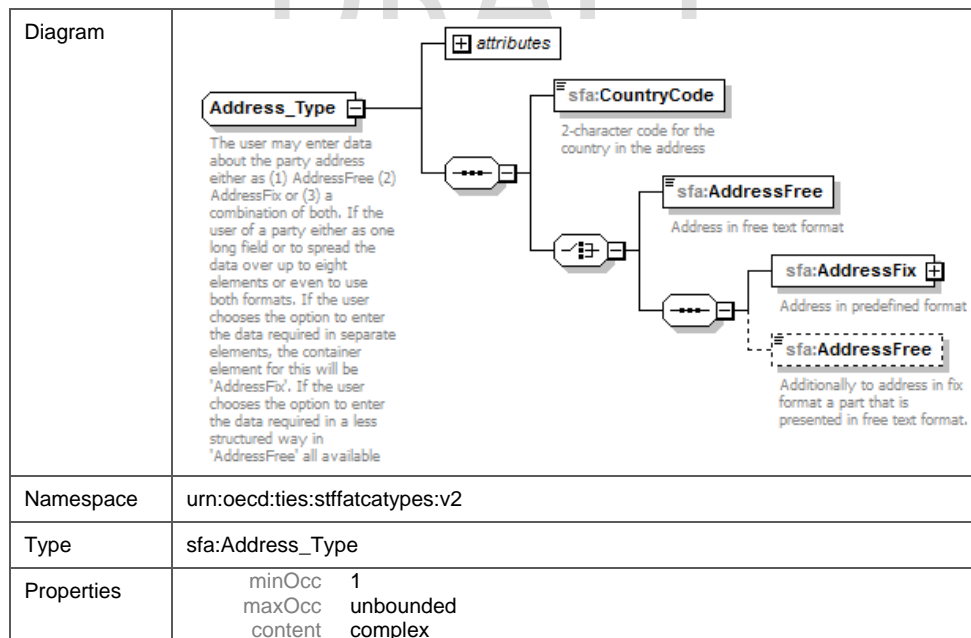

Table 11 - Address_Type

Element	Attribute	Size	Data Type	Schema Requirement	Application Requirement
Address			sfa:Address_Type	Required	
AddressType	legalAddressType		stf:OECDLegalAddressType_EnumType	Optional	Null

The OECDLegalAddressType_EnumType datatype for an address indicates the legal character of that address as residential or business. The attribute is not used for FATCA reporting and may be omitted.

Value	Description
OECD301	Residential or Business
OECD302	Residential
OECD303	Business
OECD304	Registered Office
OECD305	Unspecified

4.3.1 CountryCode

Element	Attribute	Size	Data Type	Schema Requirement	Application Requirement
CountryCode		2 characters	iso:CountryCode_Type	Required	

This data element provides the country code associated with the address. The country code is a 2-character alphabetic country code specified in the ISO 3166-1 Alpha 2 standard.

4.3.2 Address Free

Element	Attribute	Size	Data Type	Schema Requirement	Application Requirement
AddressFree		Max 4000	sfa:StringMax4000_Type	Optional	

This data element allows free text input of the address for the individual or organization. AddressFree should only be used if the data cannot be presented in the AddressFix format and the sender cannot define the various parts of the address.

- The address shall be presented as one string of bytes, blank, slash (/) or carriage return line feed used as a delimiter between parts of the address.
- AddressFree can be used as a supplemental element after the AddressFix element and when the AddressFix format is selected for address.

4.3.3 AddressFix

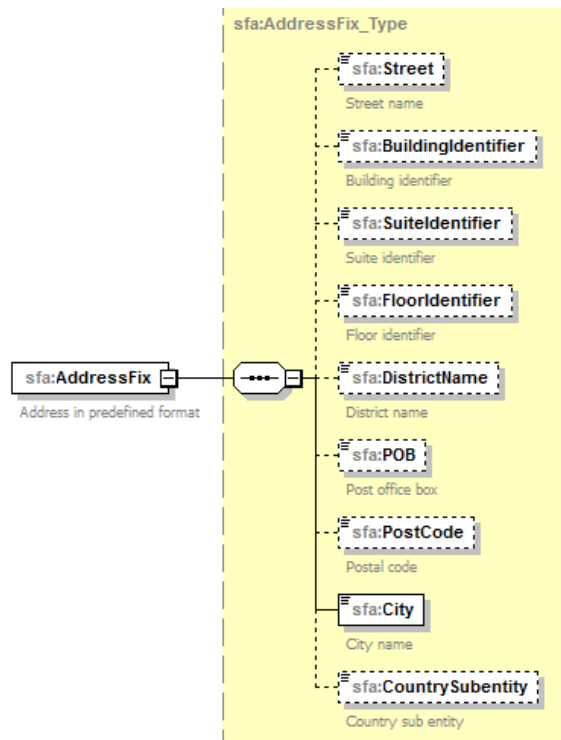

Figure 4 – AddressFix element

This data element allows input in fixed format for the address for the individual or organization.

- In AddressFix element, enter the address and if additional information is needed, use the supplemental AddressFree element. In this case, the city, subentity, and postal code information should be entered in the appropriate data elements.
- All elements are optional, except the City element which is required for schema validation.

Element(s)	Attribute	Size	Data Type	Schema Requirement	Application Requirement
Street			sfa:StringMax200_Type	Optional	
BuildingIdentifier			sfa:StringMax200_Type	Optional	
SuiteIdentifier			sfa:StringMax200_Type	Optional	
FloorIdentifier			sfa:StringMax200_Type	Optional	
DistrictName			sfa:StringMax200_Type	Optional	
POB			sfa:StringMax200_Type	Optional	
PostCode			sfa:StringMax200_Type	Optional	
City			sfa:StringMax200_Type	Required	
CountrySubentity			sfa:StringMax200_Type	Optional	

4.4 PersonParty_Type

The PersonParty_Type is a correctable party type that identifies the account holder or substantial owner that is a natural person. The Name and Address data elements are mandatory. The business rules and structure of each subelement may be defined elsewhere in the schema. For more information, review Section 6.4.4.2. AccountHolder – OrganisationParty_Type.

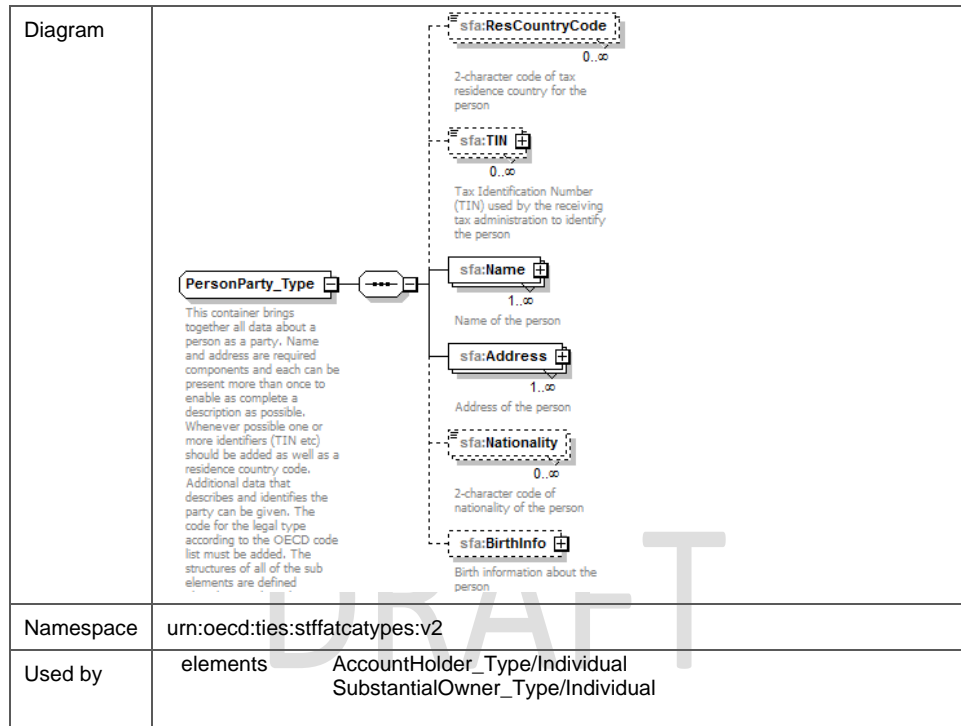

Table 12 - PersonParty_Type

4.4.1 ResCountryCode

Element	Attribute	Size	Data Type	Schema Requirement	Application Requirement
ResCountryCode		2-characters	iso:CountryCode_Type	Optional	

This data element describes the tax residence country code for the reported individual account holder or substantial owner. The country code is a 2-character alphabetic country code specified in the ISO 3166-1 Alpha 2 standard.

4.4.2 TIN

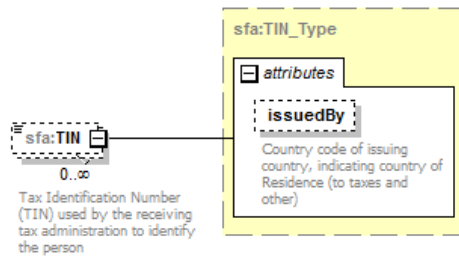

Figure 5 - TIN - PersonParty

Element	Attribute	Size	Data Type	Schema Requirement	Application Requirement
TIN		Min 1 char	sfa:TIN_Type	Optional	Mandatory
TIN	issuedBy	2-digit	iso:CountryCode_Type	Optional	

This data element identifies the receiving tax administration or U.S. Tax Identification Number (TIN) for the individual account holder or substantial owner and the attribute identifies the jurisdiction that issued the TIN. A U.S. TIN may be a U.S. social security number (SSN) or an individual taxpayer identification number (ITIN) issued by the IRS. For FATCA reporting a blank issuedBy attribute field will be assumed to indicate the issuing jurisdiction is the United States (US). For detailed information on TIN values and organisations, go to [Section 4.5.2 OrganisationParty Type TIN](#).

Based on the IGA and filing scenario certain business rules may apply:

- If the filer is an FI or direct reporting NFFE, a U.S. TIN for an account holder or substantial owner is mandatory and will be validated. Do not enter the tax identification number or country code for any jurisdiction outside the US.

TIN Format

- A value for a TIN data element must be either in a GIIN format or in one of the following formats for a US TIN:
 - Nine consecutive digits without hyphens or other separators (e.g., 123456789)
 - Nine digits with two hyphens (e.g., 123-45-6789)
 - Nine digits with a hyphen entered after the second digit (e.g., 12-3456789)

Note: If the TIN field is omitted or the value is not in a valid format, the system will generate a record level error notification.

4.4.3 Name

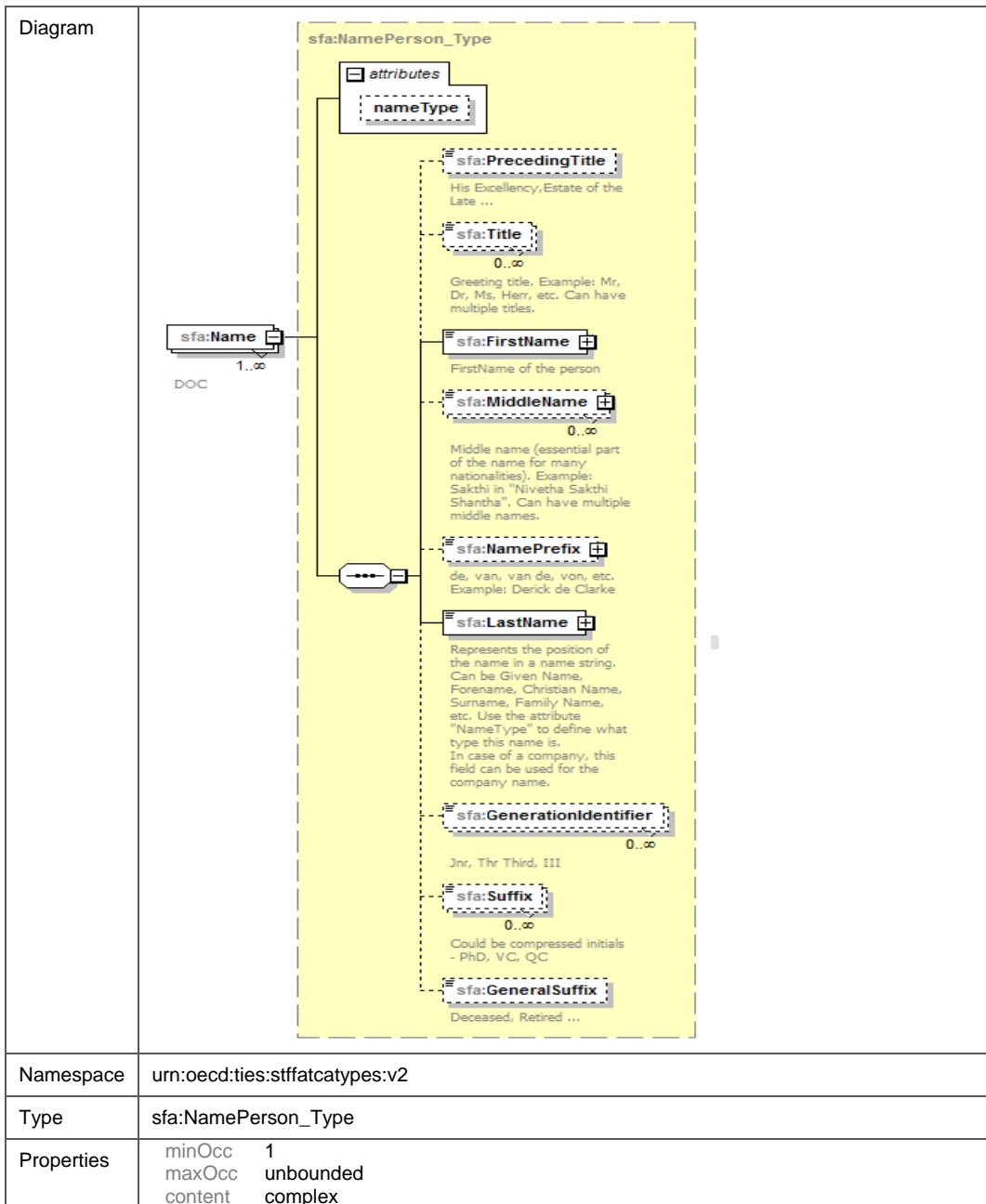

Table 13 – Name

This data element contains the components to identify an individual by name. The `FirstName` and `LastName` elements are mandatory and cannot be omitted. The attribute `nameType` is not used for FATCA reporting and should be omitted.

4.4.3.1 Titles

Element	Attribute	Size	Data Type	Schema Requirement	Application Requirement
NamePerson_Type	nameType		stf:OECDNameType_Enum Type	Optional	Null
PrecedingTitle			sfa:StringMax200_Type	Optional	Null
Title			sfa:StringMax200_Type	Optional	Null
NamePrefix			sfa:StringMax200_Type	Optional	Null
NamePrefix	xnlNameType		sfa:StringMax200_Type	Optional	Null
GenerationIdentifier			sfa:StringMax200_Type	Optional	Null
Suffix			sfa:StringMax200_Type	Optional	Null
GeneralSuffix			sfa:StringMax200_Type	Optional	Null

These data elements and attributes are not required for FATCA and may be omitted.

4.4.3.2 First Name

Element	Attribute	Size	Data Type	Schema Requirement	Application Requirement
FirstName			sfa:StringMax200_Type	Required	
FirstName	xnlNameType		sfa:StringMax200_Type	Optional	Null

This data element allows for the individual's first name. It is required for FATCA reporting and cannot be omitted.

- If the sender does not have complete information or no first name for an individual account holder or substantial owner, you may use an initial here, such J.T. or enter "NFN" (No First Name). The attribute xnlNameType is not required for FATCA reporting and may be omitted.

4.4.3.3 Middle Name

Element	Attribute	Size	Data Type	Schema Requirement	Application Requirement
MiddleName			sfa:StringMax200_Type	Optional	
MiddleName	xnlNameType		sfa:StringMax200_Type	Optional	Null

This data element allows for the individual's middle name. If the account holder or substantial owner has a middle name or initial it may be included. The data is optional and the attribute xnlNameType is not used for FATCA and may be omitted.

4.4.3.4 Last Name

Element	Attribute	Size	Data Type	Schema Requirement	Application Requirement
LastName			sfa:StringMax200_Type	Required	
LastName	xnlNameType		sfa:StringMax200_Type	Optional	Null

This data element allows for the individual's last name. This field may include any prefix or suffix legally used by the account holder or substantial owner. This element is required for FATCA reporting and cannot be omitted. The xnlNameType attribute is not used for FATCA reporting and may be omitted.

Note: If there are account holders or substantial owners with the same first and last name, use the MiddleName or other elements to distinguish the individuals.

4.4.4 Nationality

Element	Attribute	Size	Data Type	Schema Requirement	Application Requirement
Nationality		2-digit	iso:CountryCode_Type	Optional	Null

This data element is not required for FATCA and should be omitted.

DRAFT

4.4.5 BirthInfo

This data element identifies the date of birth of the individual account holder or substantial owner and may be used by HCTA and tax administrations that are permitted to provide date of birth information in lieu of a TIN for the account holder or substantial owner of a preexisting account, in circumstances described in an applicable IGA.

Diagram	
Namespace	urn:oe.cd:ties:sfifatcatypes:v2
Properties	minOcc 0 maxOcc 1 content complex

Table 14 – BirthInfo

4.4.5.1 BirthDate

Element	Attribute	Size	Data Type	Schema Requirement	Application Requirement
BirthDate			xsd:date	Optional	

This data element is used only when the message sender is another tax administration that is permitted to provide a date of birth in lieu of a TIN for a preexisting account under an applicable IGA. It may be omitted if the tax administration has not received date of birth information from the financial institution or if a US TIN (if the sender is an HCTA) or a foreign TIN (for reciprocal reports) is provided for the account holder or substantial owner. The data format is YYYY-MM-DD.

Element	Attribute	Size	Data Type	Schema Requirement	Application Requirement
City			sfa:StringMax200_Type	Optional	Null
CitySubentity			sfa:StringMax200_Type	Optional	Null
CountryInfo			sfa:StringMax200_Type	Optional	Null
CountryCode		2-characters	iso:CountryCode_Type	Optional	Null
FormerCountryName			sfa:StringMax200_Type	Optional	Null

The data elements above identify the account holder's place of birth. The CountryInfo data element provides a choice between the current country (identified by 2-character country code or a former country (identified by name)). The elements are not used for FATCA reporting and should be omitted.

4.5 OrganisationParty_Type

The OrganisationParty_Type identifies information about any entity included in the report (e.g., an entity account holder or payee, an entity substantial owner, Reporting FI, Sponsor and Intermediary (if any)). The Name and Address data elements are required components and each can be presented more than once. One or more identifiers, such as the TIN, should be added as well as a residence country code. The element has been extended by adding two categories. The structures of the sub-elements are described [Section 4.6. CorrectableReportOrganisation_Type](#).

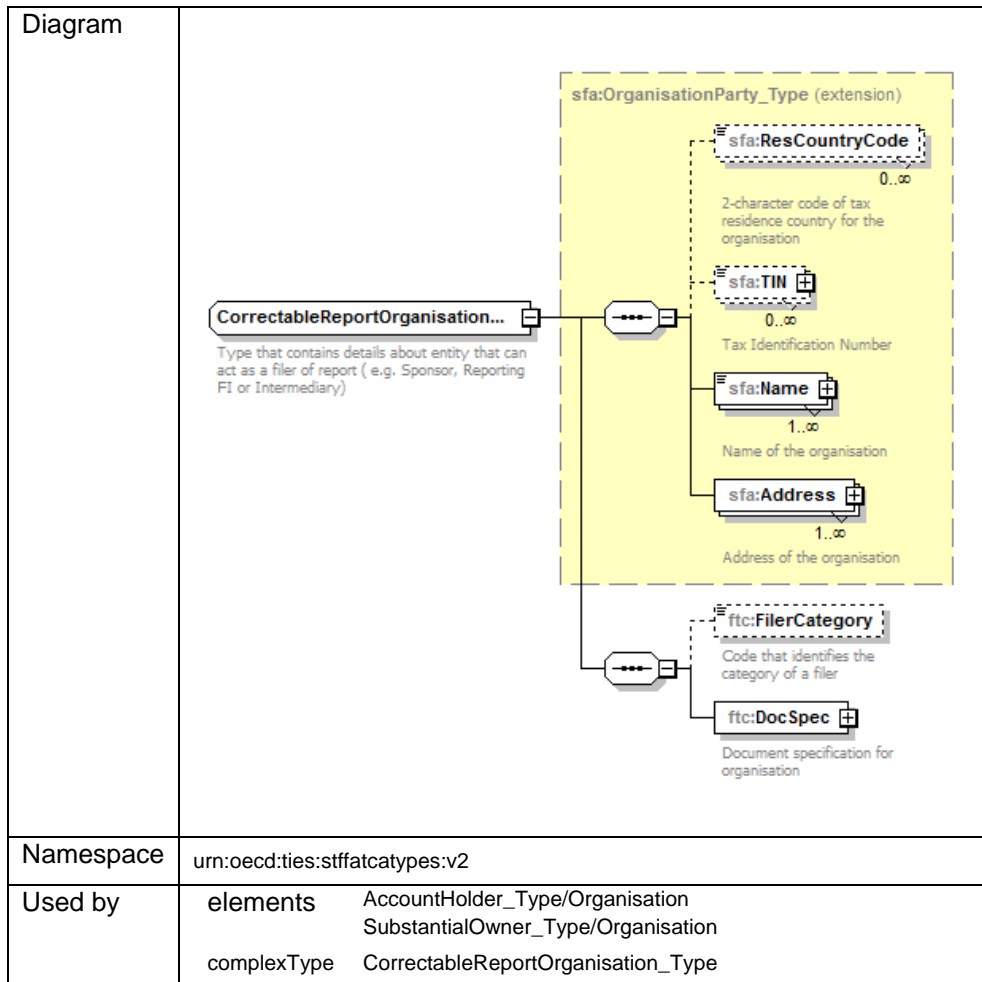

Table 15 - OrganisationParty_Type

4.5.1 ResCountryCode

Element	Attribute	Size	Data Type	Schema Requirement	Application Requirement
ResCountryCode		2-digit	iso:CountryCode_Type	Optional	

This data element describes the tax residence country code for the organization. The country code is a 2-character alphabetic country code specified in the ISO 3166-1 Alpha 2 standard.

4.5.2 TIN

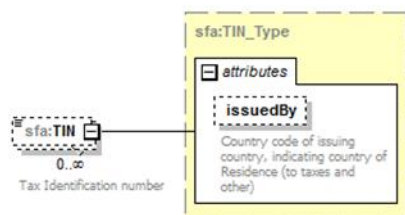

Figure 6 - TIN - OrganisationParty

Element	Attribute	Size	Data Type	Schema Requirement	Application Requirement
TIN		Min 1 char	sfa:TIN_Type	Optional	Mandatory
TIN	issuedBy	2-digit	iso:CountryCode_Type	Optional	

This element identifies the receiving tax administration or U.S. Tax Identification Number (TIN) for the organization. The attribute describes the jurisdiction that issued the TIN and reporting a blank issuedBy attribute field indicates the issuing jurisdiction is the United States (US). The data element can be repeated if a second TIN is present.

Based on the IGA and FI filing scenarios certain business rules may apply. See Sections 5, 6.1, 6.2, 6.4.4.2.1, and 6.4.5 for the applicable business rules for the TIN for reporting FI, sponsor, intermediary, entity account holder, and entity substantial owner.

TIN Format

- A value for a TIN data element must be either in a GIIN format or in one of the following formats for a U.S. TIN:
 - Nine consecutive digits without hyphens or other separators (e.g., 123456789)
 - Nine digits with two hyphens (e.g., 123-45-6789)
 - Nine digits with a hyphen entered after the second digit (e.g., 12-3456789)

Note: Do not use a FIN for any TIN elements outside of the MessageSpec element or in the body of the FATCA XML report. The FIN is entered in the message header for filing purposes only. If the TIN field is omitted or the value is not in a valid format, the IRS will generate a record level error notification.

4.5.3 Name

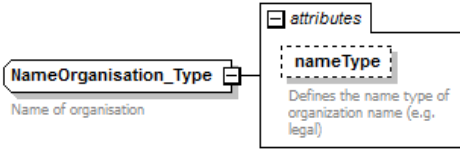

Figure 7 - NameOrganisation_Type

Element	Attribute	Size	Data Type	Schema Requirement	Application Requirement
Name			sfa:NameOrganisation_Type	Required	
Name	nameType		stf:OECDNameType_EnumType	Optional	Null

This data element describes the legal name of the entity or organization. The OECDNameType_EnumType provides data when there may be several names for the same party. Such types may include nicknames ('nick'), names under which a party does business ('dba' a short name for the entity, or a name that is used for public acquaintance instead of the official business name) etc. The IRS will generate an error if the name consists of blank characters. The attribute nameType is not required for FATCA report and should be omitted.

Value	Description	Value	Description
OECD201	SMF Alias or other	OECD205	AKA (also known as)
OECD202	Individual	OECD206	DBA (doing business as)
OECD203	Alias	OECD207	Legal
OECD204	Nick (Nickname)	OECD208	At Birth

4.5.4 Address

Element	Attribute	Size	Data Type	Schema Requirement	Application Requirement
Address			sfa:Address_Type	Required	

This data element is described elsewhere in the schema. For more information, go to [Section 4.3. Address_Type](#).

4.6 CorrectableReportOrganisation_Type

This data type transmits data for Reporting FI, Sponsor, and Intermediary organizations and was extended from the OrganisationParty_Type by adding two elements; FilerCategory and DocSpec. The structures of the sub-elements are described [Section 4.5. OrganisationParty_Type](#).

4.6.1 FilerCategory - New

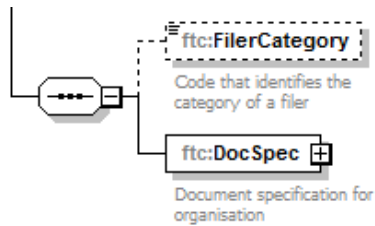

Figure 8 - FilerCategory

Element	Attribute	Size	Data Type	Schema Requirement	Application Requirement
FilerCategory			ftc:FatcaFileCategory_EnumType	Optional	Mandatory

This data element identifies the filer category codes and may be required based on specific filing status, such as direct reporting NFFE and Sponsoring Entities filing on behalf of direct reporting NFFEs. The element or code may not be presented more than once.

Application Requirement:

Member of Reporting FI Group	Business Rule
Reporting FI	<ul style="list-style-type: none"> If the reporting FI is not a Sponsored FFI, Sponsored Direct Reporting NFFE, or Trustee-Documented Trust, the element is mandatory. If the reporting FI is a Sponsored FFI, Sponsored Direct Reporting NFFE, or Trustee-Documented Trust, the element is not allowed. The only allowable values as shown below in Table 16. Filer category list.
Intermediary	<ul style="list-style-type: none"> The element is not allowed to be associated with the element Intermediary.
Sponsor	<ul style="list-style-type: none"> The element is mandatory if the report contains a Sponsoring Entity. The filer category element should be associated with the Sponsor element. This element will be validated on application level and if not present, will generate a record level error notification. The only allowed values are FATCA 607, FATCA 608 or FATCA 609. See additional business rules in Section 6.1. Sponsor.

Note: The FilerCategory element is reported under either the ReportingFI or the Sponsor element. It should never to be included in an Intermediary element. The values and rules for inclusion of FilerCategory are provided in Table 16. Filer category list.

Filer Category Types:

If the financial institution reporting the account is a:	FilerCategory for element	FilerCategory Value
PFFI (other than a Reporting Model 2 FFI and including a U.S. branch of a PFFI not treated as a U.S. person)	Reporting FI	FATCA601
RDC FFI	Reporting FI	FATCA602
Limited Branch or Limited FFI	Reporting FI	FATCA603
Reporting Model 2 FFI	Reporting FI	FATCA604
Qualified Intermediary (QI), Withholding Foreign Partnership (WP), or Withholding Foreign Trust (WT)	Reporting FI	FATCA605
Direct Reporting NFFE	Reporting FI	FATCA606
Sponsoring Entity of a Sponsored FFI	Sponsor	FATCA607*
Sponsoring Entity of a Sponsored Direct Reporting NFFE	Sponsor	FATCA608*
Trustee of a Trustee-Documented Trust	Sponsor	FATCA609*
Withholding Agent (including a U.S. branch of a PFFI, Reporting Model 1 FFI, Reporting Model 2 FFI, RDC FFI treated as a U.S. person and a U.S. branch of a Reporting Model 1 FFI (including any other RDC FFI) Limited FFI that is not treated as a U.S. person)	Reporting FI	FATCA610
Territory Financial Institution treated as a U.S. person	Reporting FI	FATCA611

Table 16 - Filer category list

4.6.2 DocSpec

For more information and a description of this element, go to [Section 4.2. DocSpec Type](#).

5 Reporting FI

The ReportingFI data element uses the CorrectableReportOrganisation_Type to identify the financial institution that maintains the financial account, the financial institution that makes the payment, or the direct reporting NFFE that reports its owners. The structure and sub-elements elements are described in [Section 4.5 OrganisationParty_Type](#) and [Section 4.6 CorrectableReportOrganisation_Type](#).

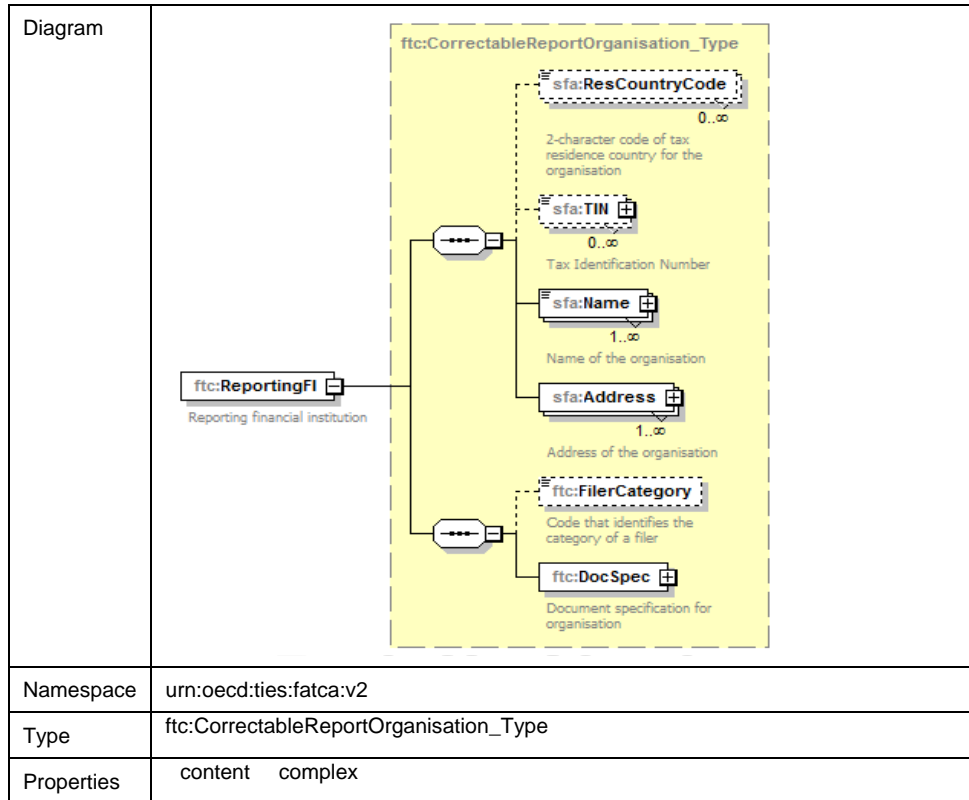

Table 17 – ReportingFI

This data element identifies the FI or NFFE that maintains a reportable account, makes a payment, or is a Direct Reporting NFFE required to report its owners. If the reporting FI maintains branches outside of its country of tax residence then the GIIN for the reporting FI is the GIIN associated with the branch of the reporting FI that maintains the reported financial account.

Reporting FI

A ReportingFI may be one of the entities identified in the table below. See Section 1.1 for a summary of when reporting under FATCA is required.

- If a Sponsoring Entity is filing a report for a Sponsored FFI or Sponsored Direct Reporting NFFE, information about the Sponsored FFI or Sponsored Direct Reporting NFFE should be reported in the ReportingFI element; information about the Sponsoring Entity should be reported in the Sponsor element in the ReportingGroup.
- If a Trustee is filing a report for a Trustee-Documented Trust, information about the Trustee-Documented Trust should be reported in the ReportingFI element; information about the Trustee of the Trustee-Documented Trust should be reported in the Sponsor element in the ReportingGroup.

TIN Value for ReportingFI

The list below summarizes the category and TIN values for a ReportingFI. This element is described in other parts of the schema. For more information, go to [Section. 4.5.2 OrganisationParty_Type TIN](#).

TIN Values:

Reporting FI	GIIN	EIN	Description
Participating FFI (including a Reporting Model 2 FFI)	•		Enter the GIIN of the FFI (or, if applicable, the branch that maintains the account).
Registered Deemed-Compliant FFI (RDC FFI)	•		Enter the GIIN of the FFI (or, if applicable, the branch that maintains the account).
Reporting Model 1 FFI	•		Enter the GIIN of the FFI (or, if applicable, the branch that maintains the account).
Limited Branch or Limited FFI			Leave the TIN element blank.*
Direct Reporting NFFE	•		Enter its GIIN.
QI, WP, or WT	•	•	Enter both its GIIN and its QI-EIN, WP-EIN, or WT-EIN.
Territory Financial Institution treated as U.S. person		•	Enter its U.S. EIN.
Withholding Agent		•	Enter its U.S. EIN.
Sponsored FFI (other than a sponsored, closely held investment vehicle)	•		Enter its GIIN.
Sponsored FFI that is a sponsored, closely held investment vehicle			Leave the TIN element blank.*
Sponsored Direct Reporting NFFE	•		Enter its GIIN.
Sponsored Subsidiary Branch	•		Enter its GIIN.
Trustee-Documented Trust			Leave the TIN element blank.*

Table 18 - TIN values for ReportingFI

Note: Do not use a FIN for any TIN elements outside of the MessageSpec elements or in the body of the FATCA XML report. The FIN is entered in the message header for filing purposes only.

*Note: If the TIN field is omitted or the value is not in a valid format, the IRS will generate a record level error notification. **The IRS has issued guidance that the notification may be disregarded in certain circumstances.**

Filer Category for ReportingFI

For more information, go to [Section 4.6.1 FilerCategory](#). Unless otherwise noted, for all other reporting FIs, the filer category is mandatory. The list below summarizes the allowable values are for a reporting FI.

Filer Category Values:

If the financial institution reporting the account is a:	FilerCategory for element	FilerCategory Value
PFFI (other than a Reporting Model 2 FFI and including a U.S. branch of a PFFI not treated as a U.S. person)	Reporting FI	FATCA601
RDC FFI (including a Reporting Model 1 FFI)	Reporting FI	FATCA602
Limited Branch or Limited FFI	Reporting FI	FATCA603
Reporting Model 2 FFI	Reporting FI	FATCA604
Qualified Intermediary (QI), Withholding Foreign Partnership (WP), or Withholding Foreign Trust (WT)	Reporting FI	FATCA605
Direct Reporting NFFE	Reporting FI	FATCA606
Withholding Agent (including a U.S. branch of a PFFI, Reporting Model 1 FFI, Reporting Model 2 FFI, RDC FFI treated as a U.S. person and a U.S. branch of a Reporting Model 1 FFI (including any other RDC FFI) Limited FFI that is not treated as a U.S. person)	Reporting FI	FATCA610
Territory Financial Institution treated as a U.S. person	Reporting FI	FATCA611

Table 19 - FileCategory values for ReportingFI

- If an HCTA in a Model 1 IGA jurisdiction is sending information on accounts maintained by a Reporting Model 1 FFI, use filer category FATCA602 (RDC FFI).
- If the reporting FI is a Related Entity or branch described in an applicable IGA, use filer category code FATCA603 (Limited Branch or Limited FFI).
- If reporting FI is a Sponsored FFI, Sponsored Direct Reporting NFFE, or Trustee-Documented Trust, the **filer category is not allowed**. For more information, go to [Section 6.1 Sponsor](#).

Address for ReportingFI

For more information, go to [Section 4.3 Address Type](#). Enter the reporting FI's mailing address. If the reporting FI is a participating FFI, provide the mailing address of the office of the branch that maintains the account.

6 ReportingGroup

The ReportingGroup data element uses the CorrectableReportOrganisation_Type to identify

(1) a Sponsoring Entity or Trustee of a Trustee-Documented Trust that it is acting on behalf a Sponsored FFI, Sponsored Direct Reporting NFFE, or Trustee-Documented Trust (as applicable) that maintains the reported financial account, or (2) an Intermediary receiving a withholdable payment or holding an account with the reporting FI that provides the reporting FI with information on certain beneficial owners.

The structure and sub-elements are described in [Section 4.5 OrganisationParty_Type](#) and [Section 4.6 CorrectableReportOrganisation_Type](#).

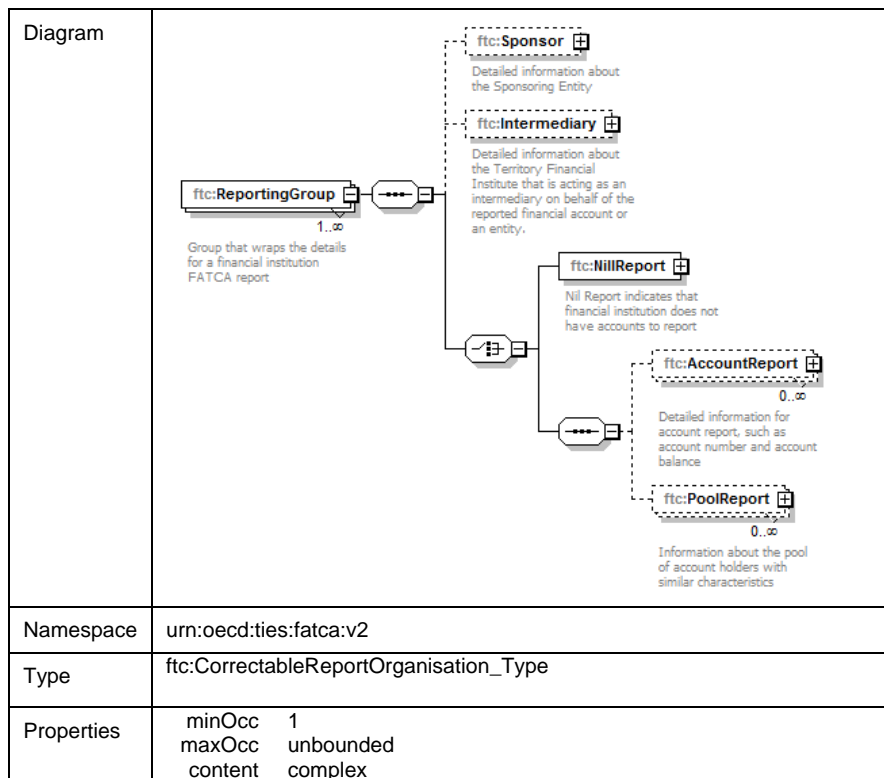

Table 20 – ReportingGroup

The data element provides specific account data and each FATCA Report must contain a Nil Report or AccountReport(s) and/or a PoolReport(s).

6.1 Sponsor

Element	Attribute	Size	Data Type	Schema Requirement	Application Requirement
Sponsor			ftc:CorrectableOrganisationParty_Type	Optional	

This data element identifies a Sponsoring Entity or a Trustee of a Trustee-Documented Trust that has agreed to report on behalf a Sponsored FFI, Sponsored Direct Reporting NFFE, or Trustee-Documented Trust (as applicable). Information on the Sponsored FFI, Sponsored Direct Reporting NFFE, or Trustee-Documented Trust should be entered in the Reporting FI element. The Sponsor structure and sub-elements are described in [Section 4.5 OrganisationParty_Type](#) and [Section 4.6 CorrectableReportOrganisation_Type](#).

TIN Value for Sponsoring Entity

- The TIN of a Sponsoring Entity is the GIIN issued to such entity when it is acting in its capacity as a Sponsor.
- The Sponsor should use their Sponsoring Entity’s GIIN as a TIN value. It may also be included in an original data element for a corrected, amended, or voided record.
- The TIN of a Trustee of a Trustee-Documented Trust is the GIIN it received when it registered to act as a trustee of a Trustee-Documented Trust. The GIINs should contain “SP”.

Note: Do not use a FIN under FATCA data elements in the body of the report. If the sender is a non-GIIN filer, that obtained a FIN. The FIN is entered in the message header for filing purposes only.

If the TIN field is omitted or the value is not in a valid format, the system will generate a record level error notification.

Filer Category for Sponsoring Entity

- This element is mandatory for a Sponsor. It will be validated on the application level and if not present, will generate a record level error notification. For more information, go to [Section 4.6.1 FilerCategory](#). The list below summarizes the allowable values for a Sponsor.

If the financial institution reporting the account is a:	FilerCategory for element	FilerCategory Value
Sponsoring Entity of a Sponsored FFI	Sponsor	FATCA607
Sponsoring Entity of a Sponsored Direct Reporting NFFE	Sponsor	FATCA608
Trustee of a Trustee-Documented Trust	Sponsor	FATCA609

6.2 Intermediary

Element	Attribute	Size	Data Type	Schema Requirement	Application Requirement
Intermediary			ftc:CorrectableOrganisationParty_Type	Optional	

This data element identifies an Intermediary that is:

- A Territory Financial Institution not treated as a U.S. person that is acting as an intermediary or is a flow-through entity and receives a withholdable payment from a withholding agent or holds an account with a Participating FFI (including a Reporting Model 2 FFI) (the withholding agent or Participating FFI (including a Reporting Model 2 FFI) is the Reporting FI); or

- A certified deemed-compliant FFI that is acting as an intermediary for a withholdable payment and provides the withholding agent with information on a substantial U.S. owner of a passive NFFE account holder or payee (the withholding agent is the Reporting FI).

The structure and sub-elements are described in [Section 4.5 OrganisationParty Type](#) and [Section 4.6 CorrectableReportOrganisation](#).

TIN Value for Intermediary

- If the Intermediary is a Territory Financial Institution not treated as a U.S. person, enter the TIN issued to the Territory Financial Institution by the IRS, or if the Territory Financial Institution has not been issued a TIN by the IRS, enter the EIN assigned to the entity by the relevant U.S. territory.
- If the Intermediary is a certified deemed-compliant acting as an intermediary, the entity will not have a GIIN or U.S. TIN or EIN. Leave the TIN element blank.

Filer Category

- Element is not allowed and if present will generate an error message.

6.3 NilReport - New

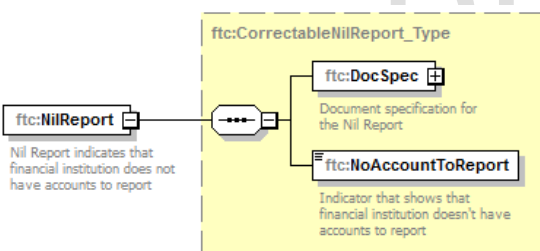

Figure 9 - NilReport

Element	Attribute	Size	Data Type	Schema Requirement	Application Requirement
NilReport			ftc:CorrectableNilReport_Type	Choice	

This data element specifies that a financial institution has no accounts to report or that a Direct Reporting NFFE (or Sponsored Direct Reporting NFFE) has no substantial U.S. owners. Generally, a Nil Report is optional for filers other than Direct Reporting NFFEs and Sponsored Direct Reporting NFFEs. Nil reports that are submitted must also include ReportingFI and Sponsor or Intermediary, if applicable.

Also note that nil reporting may be required by a financial institution's local jurisdiction. Consult your local tax administration for details. For more information on sample nil reports, go to <https://www.irs.gov/Businesses/Corporations/FATCA-XML-Schemas-and-Business-Rules-for-Form-8966>.

Schema Requirement: Nil Report is one of the options in xsd:choice. It is a required element in the choice, but if another option is selected then Nil Report may not be included in the element. If a Nil Report for a reporting FI is submitted and accepted, then an Account or Pool Report cannot be submitted for the same reporting FI in the same tax year, until the Nil Report has been voided. If an Account Report or Pool Report are submitted and accepted, then a Nil Report cannot be submitted for the same reporting FI in the same tax year, until the Account Report or Pool Report has been voided.

6.3.1 DocSpec

This data element is used to void, amend or correct a Nil Report. It uniquely identifies the FATCA report being transmitted and is described in [Section 4.2. DocSpec](#). For example, if you file a Nil Report and discover that you have accounts to report, you can void the Nil Report and submit an Account and/or Pool Report as new data. If any data element in the Nil Report needs to be updated, you can also submit an amended Nil Report.

6.3.2 NoAccountToReport

Element	Attribute	Size	Data Type	Schema Requirement	Application Requirement
NoAccountToReport			xsd:string	Required	

This data element is a fixed element and indicates there are no accounts to report. The only allowable value is “yes”.

6.4 Account Report

This data element contains detailed information on the accounts or payments required to be reported. The AccountReport uses the CorrectableAccountReport_Type and contains the account holder, account balance and other related account information.

Diagram	<p>The diagram illustrates the structure of the <code>CorrectableAccountReport_Type</code> element. It is a complex type that contains the following elements:</p> <ul style="list-style-type: none"> <code>ftc:DocSpec</code>: Document specification for the account report. <code>ftc:AccountNumber</code>: Financial institution account number used to uniquely identify the account holder or payee. <code>ftc:AccountClosed</code>: The indicator whether the financial institution account status is closed for the account holder or payee. <code>ftc:AccountHolder</code>: Detailed information of the entity account holder or payee. <code>ftc:SubstantialOwner</code>: Detailed information of the substantial owner of the account. Cardinality: 0..∞. <code>ftc:AccountBalance</code>: The account balance or value of the reported financial account. <code>ftc:Payment</code>: The aggregate gross payment made to the reported financial account or to an entity that is not an account holder. Payment information is a repeating element, if more than one payment type needs to be reported. Cardinality: 0..∞. <code>ftc:CARRef</code>: Contains identifying information for Competent Authority Request (CAR). Required when account report is sent as a response to a Competent Authority Request (CAR). Used to associate the response to Competent Authority Request to a pooled report. <code>ftc:AdditionalData</code>: Additional data. 						
Namespace	urn:oe.cd:ties:fatca:v2						
Type	ftc:CorrectableAccountReport_Type						
Properties	<table border="0"> <tr> <td>minOcc</td> <td>0</td> </tr> <tr> <td>maxOcc</td> <td>unbounded</td> </tr> <tr> <td>content</td> <td>complex</td> </tr> </table>	minOcc	0	maxOcc	unbounded	content	complex
minOcc	0						
maxOcc	unbounded						
content	complex						

Table 21 – AccountReport

6.4.1 DocSpec

This element is used to correct, void or amend an Account Report record. It uniquely identifies the FATCA report being transmitted and is described in [Section 4.2. DocSpec](#).

6.4.2 AccountNumber

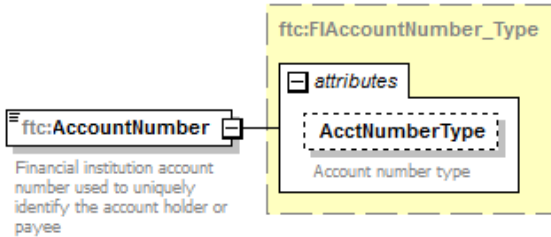

Figure 10 - AccountNumber

Element	Attribute	Size	Data Type	Schema Requirement	Application Requirement
AccountNumber			ftc:FIAccountNumber_Type	Required	
AccountNumber	AcctNumberType		stf:AcctNumberType_Enum Type	Optional	

This data element provides the account number assigned by the financial institution to uniquely identify the account holder.

- If the account is assigned an account type number, including alpha numeric identifiers, the element may be mandatory. An account number can be any of the following:
 - Account number of a custodial account or depository account
 - Code (ISIN or other) related to a debt or equity interest (if not held in a custody account)
 - Identification code of a cash value insurance contract or annuity contract
- If the financial institution has no account numbering system, then enter “NANUM” for no account number.
- If the reporting FI is a withholding agent reporting a withholdable payment made to a payee that is not an account holder, enter NANUM for no account number.
- If the reporting FI is a Direct Reporting NFFE, enter NANUM for no account number.

AcctNumber_Type

This attribute AcctNumber_Type is not required for FATCA reporting and can be omitted. If it is included, then the value should be from the list below:

Values	Description of FIAccountNumber_Type	
OECD601	IBAN	International Bank Account Number used in some countries to uniquely identify a customer's bank account.
OECD602	OBAN	Other Bank Account Number
OECD603	ISIN	International Securities Identification Number uniquely identifies securities, such as bonds, commercial paper, stocks and warrants.
OECD604	OSIN	Other Securities Identification Number
OECD605	Other	Any other type of unique identifier codes or account number, i.e. insurance contract

6.4.3 AccountClosed - New

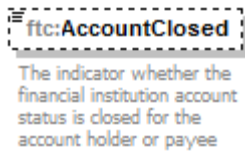

Figure 11 - AccountClosed

Element	Attribute	Size	Data Type	Schema Requirement	Application Requirement
AccountClosed			xsd:boolean	Optional	

This data element indicates the account was closed or transferred in its entirety during the calendar year. If an account holder rolls over the amounts in one account (or type of account) into another account (or another type of account) with the same FFI during the calendar year, do not report the account as closed. Application requirement: FFIs reporting an account that is closed or transferred in its entirety should complete this element. Withholding agents should not complete this element.

6.4.4 AccountHolder

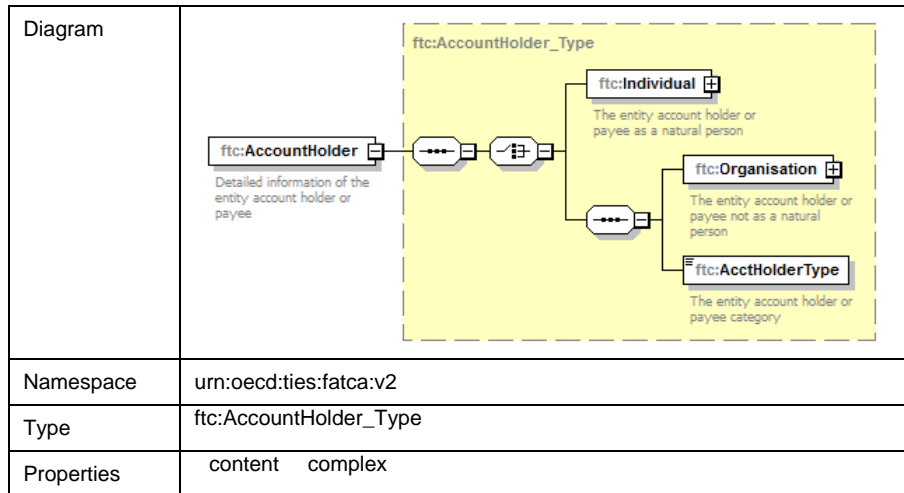

Table 22 – AccountHolder

This data element provides detailed information about the account holder or payee that is an individual or organization. The AccountHolder is a choice which has two options, Individual and Organisation.

6.4.4.1 Individual

Element	Attribute	Size	Data Type	Schema Requirement	Application Requirement
Individual			sfa:PersonParty_Type	Choice	

This data element provides detailed information and identifies the account holder as a natural person. The structure of the AccountHolder as an Individual is described [in Section 4.4. PersonParty_Type](#).

Individual Account Holder - Address: Enter the account holder's or payee's residence address. If the sender does not have a residence address on file for the individual, then enter the mailing address used by the financial institution to contact the individual account holder or payee.

6.4.4.2 Organisation

Element	Attribute	Size	Data Type	Schema Requirement	Application Requirement
Organisation			sfa:OrganisationParty_Type	Choice	

This data element provides detailed information and identifies the account holder as not a natural person. The structure of the AccountHolder that is an Organisation is described in [Section 4.5. OrganisationParty_Type](#).

Organization Account Holder - Address: The Name and Address data elements are required components and each can be presented more than once. One or more identifiers, such as the TIN, should be added as well as a residence country code.

If the entity account holder or payee has been assigned a US TIN, enter that number. If the entity account holder or payee does not have a US TIN (e.g., a passive NFFE, owner-documented FFI, or nonparticipating FFI), leave the TIN element blank. Do not enter the tax identification number or country code for any jurisdiction outside the US.

Note: Direct Reporting NFFEs should enter the NFFE organization information for this data element.

6.4.4.3 AcctHolderType - Updated

Element	Attribute	Size	Data Type	Schema Requirement	Application Requirement
AcctHolderType			ftc:FatcaAcctHolderType_EnumType	Required	

This data element is required if the account holder is an organization and identifies an entity account holder or payee. The AcctHolderType data element must be presented as one of the values listed below:

AcctHolderType

Value	Description
FATCA101	Owner Documented FFI with specified US owners (ODFFI)
FATCA102	Passive NFFE with substantial US owners (or controlling persons under an applicable IGA)
FATCA103	Non-Participating FFI (NPFFI)
FATCA104	Specified US person
FATCA105	Direct Reporting NFFE
FATCA106	For US Government use only (Attention FIs and HCTAs: Restricted Do Not Use)

Important: FATCA106 should not be used for FATCA reporting to the IRS. Use of FATCA106 will generate an error message. Beginning tax year 2016 and later, FATCA105 can be used only if the filer category is FATCA606.

6.4.5 Substantial Owner - Updated

Diagram	
Namespace	urn:oe.cd:ties:fatca:v2
Type	ftc:SubstantialOwner_Type
Properties	minOcc 0 maxOcc unbounded content complex

Table 23 - SubstantialOwner

This data element identifies certain owners of the account holder or payee, and the substantial U.S. owners of a direct reporting NFFE. The SubstantialOwner element supports entities and organizations and describes the account holder as an individual in [Section 4.4. PersonParty_Type](#) or organization in [Section 4.5. OrganisationParty_Type](#).

The substantial owner element may be one of the following:

- Each substantial U.S. owner (or, if applicable, controlling person that is a specified U.S. person) of a passive NFFE account holder or payee.
- Each specified U.S. person that owns certain equity or debt interests in an owner-documented FFI account holder or payee.
- Each substantial U.S. owner of a Direct Reporting NFFE (the Direct Reporting NFFE is the Reporting FI).

Note: If the entity account holder or payee is a nonparticipating FFI (NPFFI) or specified US person, do not complete the SubstantialOwner element.

6.4.5.1 Individual and Organization

Element	Attribute	Size	Data Type	Schema Requirement	Application Requirement
Substantial/Individual			PersonParty_Type	Choice	
Substantial/Organisation			OrganisationParty_Type	Choice	

These elements provides the name, address, and TIN of any specified U.S. owners of an owner documented FFI, substantial US owners (or, if applicable, controlling persons that are specified U.S. persons) of a passive NFFE, and substantial U.S. owners of a Direct Reporting NFFE. One or more substantial owners can be added.

6.4.6 AccountBalance

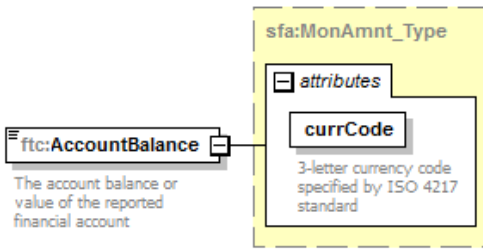

Figure 12 - AccountBalance element

Element	Attribute	Size	Data Type	Schema Requirement	Application Requirement
AccountBalance			sfa:MonAmnt_Type	Required	
AccountBalance	currCode	3 letters	iso:currCode_Type	Required	

This data element provides the account balance or value of the reported financial account or the value of the equity interest in a Direct Reporting NFFE held by a substantial U.S. owner. The appropriate attribute is the 3-letter currency code. The element allows zero (0) and negative balances. The AccountBalance is required and cannot be omitted. For more information, go to [Section 6.4.7 Payment](#).

- In general, the account balance is the average balance or value of the financial account, if the financial institution reports average balance or value to the account holder for a calendar year; otherwise, enter the balance or value of the account as of the end of the calendar year. For information for reporting the balance or value of an equity or debt interest in the FI or a cash value insurance or annuity contract, see Treasury regulations section 1.1471-5(b)(4).
- If account is closed or transferred in its entirety by an account holder during a calendar year, the account balance is the amount or value withdrawn or transferred from the account in connection with the closure or transfer.
- A withholding agent reporting a withholdable payment made to an account held by an ODFFI should enter the average calendar year balance or value if that amount is reported to the ODFFI; otherwise, enter the account balance or value as of the end of the calendar year. If the payee is a passive NFFE, enter zero (0) account balance.
- For HCTAs, the account balance or value shall be in accordance with the terms of the Model 1 IGA.
- For Direct Reporting NFFEs, the account balance is, with respect to each substantial U.S. owner, the value of the equity interest in the NFFE held by the substantial U.S. owner.
- If an FI is reporting on a specific payee basis amounts paid to a nonparticipating FFI, then enter zero (0) in the account balance element.

6.4.7 Payment

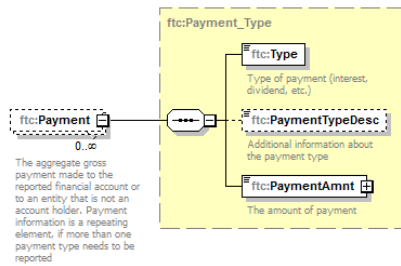

Figure 13 - Payment element

Element	Attribute	Size	Data Type	Schema Requirement	Application Requirement
Payment			ftc:Payment_Type	Optional	

This data element provides account data on certain payments made to an account, payee, or owner, as described below. More than one payment type may be reported.

If the Reporting FI is an FI reporting an account, enter the payments to the account as follows:

Depository accounts:

- The aggregate gross amount of interest paid or credited to the account during the calendar year. Use payment type FATCA502.

Custodial accounts:

- The aggregate gross amount of dividends paid or credited to the account during the calendar year. Use payment type FATCA501.
- The aggregate gross amount of interest paid or credited to the account during the calendar year. Use payment type FATCA502.
- The gross proceeds from the sale or redemption of property paid or credited to the account during the calendar year with respect to which the FFI acted as a custodian, broker, nominee, or otherwise as an agent for the account holder. Use payment type FATCA503.
- The aggregate gross amount of all other income paid or credited to the account during the calendar year reduced by reported interest, dividends, and gross proceeds. Use payment type FATCA504.

Debt or equity accounts:

- The aggregate gross amount of payments paid or credited to the account during the calendar year, including redemption payments (in whole or part) of the account. Use payment type FATCA504.

Cash value insurance and annuity contract accounts:

- The aggregate gross amount of payments paid or credited to the account during the calendar year, including redemption payments (in whole or part) of the account. Use payment type FATCA504.

Foreign reportable amounts: (2015 and 2016 only)

- The aggregate gross amount of foreign reportable amounts paid or credited to a nonparticipating FFI may be reported divided by type of payment (using payment type FATCA501, FATCA502, FATCA503, and/or FATCA504, as applicable), or the entire amount may be reported as “FATCA Other” payment (using payment type FATCA504).
- As an alternative to reporting foreign reportable amounts, the FI may instead report all income, gross proceeds, and redemptions (regardless of source) paid to the nonparticipating FFI during the calendar year (using payment type FATCA504).

If an account is closed or transferred in its entirety by an account holder during a calendar year, report the amounts paid or credited to the account for the calendar year until the date of transfer or closure using payment types FATCA501, FATCA502, FATCA503, and/or FATCA504, as applicable.

Withholding agents (other than FFIs)

Report withholdable payments to the owner-documented FFI or passive NFFE using the payment types FATCA501, FATCA502, FATCA503, and/or FATCA504, as applicable.

Direct Reporting NFFEs

Enter the total of all payments made by the NFFE during the calendar year to each substantial U.S. owner (either divided by payment type, or as one amount under FATCA504), including the gross amounts paid or credited to the substantial U.S. owner with respect to such owner’s equity interest in the NFFE during the calendar year, which include payments in redemption or liquidation (in whole or part) of the substantial U.S. owner’s equity interest in the NFFE.

6.4.7.1 Type

Element	Attribute	Size	Data Type	Schema Requirement	Application Requirement
Type			ftc.FatcaPaymentType_EnumType	Required	

This data element describes the specific payment type.

Values	Description
FATCA501	Dividends
FATCA502	Interest
FATCA503	Gross Proceeds/Redemptions
FATCA504	Other

6.4.7.2 PaymentTypeDesc - New

Element	Attribute	Size	Data Type	Schema Requirement	Application Requirement
PaymentTypeDesc		Max 4000	sfa:StringMax4000_Type	Optional	

This data element is a free text field and can be used to provide additional information about the payment type. This element is not used for FATCA reporting.

6.4.7.3 PaymentAmt

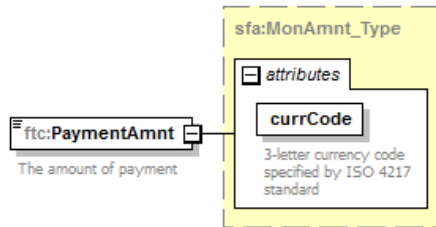

Figure 14 - PaymentAmt element

Element	Attribute	Size	Data Type	Schema Requirement	Application Requirement
PaymentAmt			sfa:MonAmnt_Type	Required	

This data element provides specific payment amount and of MonAmnt_Type as described in [Section 4.1. MonAmnt_Type](#).

DRAFT

6.4.8 CARRef - New (Model 2 IGA Reporting Only)

Diagram	
Namespace	urn:oe.cd:ties:fatca:v2
Used by	element <u>CorrectableAccountReport_Type/CARRef</u>

Table 24 – CARRef_Type

Element	Attribute	Size	Data Type	Schema Requirement	Application Requirement
CARRef			sfa:CARRef_Type	Optional	

This data element should only be included in FATCA account reports submitted in response to a Competent Authority Request (CAR). The CARRef contains identifying information for a pooled report (ReportingFI GIIN, MessageRefId, and DocRefId elements) and links the account report to the CAR and the original pool report. Any FATCA account report submitted in response to a CAR must include the CARRef element.

Note: The IRS sends a CAR to an HCTA to request additional account information, after it receives a pooled report from a Model 2 financial institution.

6.4.8.1 PoolReportReportingFIGIIN

Element	Attribute	Size	Data Type	Schema Requirement	Application Requirement
PoolReportReportingFIGIIN		Max 200	sfa:StringMax200_Type	Required	

This data element identifies the reporting financial institution (ReportingFI) GIIN associated with the original pool report.

6.4.8.2 PoolReportMessageRefId

Element	Attribute	Size	Data Type	Schema Requirement	Application Requirement
PoolReportMessageRefId		Max 200	sfa:StringMax200_Type	Required	

This data element references the MessageRefId of the FATCA XML file that contains the pool report associated with the CAR.

6.4.8.3 PoolReportDocRefId

Element	Attribute	Size	Data Type	Schema Requirement	Application Requirement
PoolReportDocRefId		Max 200	sfa:StringMax200_Type	Required	

This data element identifies the DocRefId of the pool report related to the CAR.

6.4.9 AdditionalData - New

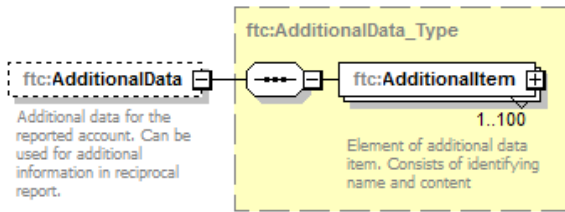

Figure 15 - AdditionalData element

Element	Attribute	Size	Data Type	Schema Requirement	Application Requirement
AdditionalData			ftc:AdditionalData_Type	Optional	

This data element provides additional information for the account report. Currently, this element is not used for FATCA reporting to the IRS.

DRAFT

6.4.9.1 AdditionalItem

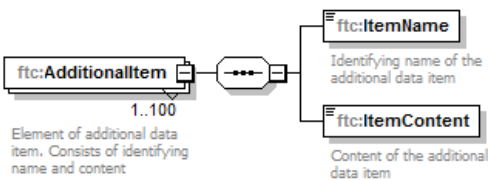

Figure 16 – AdditionalItem element

Element	Attribute	Size	Data Type	Schema Requirement	Application Requirement
AdditionalItem			ftc:AdditionalItem	Required	
ItemName		Max 200	sfa:StringMax200_Type	Required	
ItemContent		Max 4000	sfa:StringMax4000_Type	Required	

The AdditionalData data element contains one or multiple additional data items. Each item consists of descriptive name and content.

6.5 Pool Report

This data element provides information about accounts held by recalcitrant account holders (or, in the case of a reporting FI that is a Reporting Model 2 FFI, non-consenting U.S. accounts) and, for 2015 and 2016, amounts paid to nonparticipating FFIs that are reported on a pooled basis. The element uses the CorrectablePoolReport_Type to specify the report type and balances or payments. Pooled reports should not be used if the message sender is providing information pursuant to a Model 1 IGA.

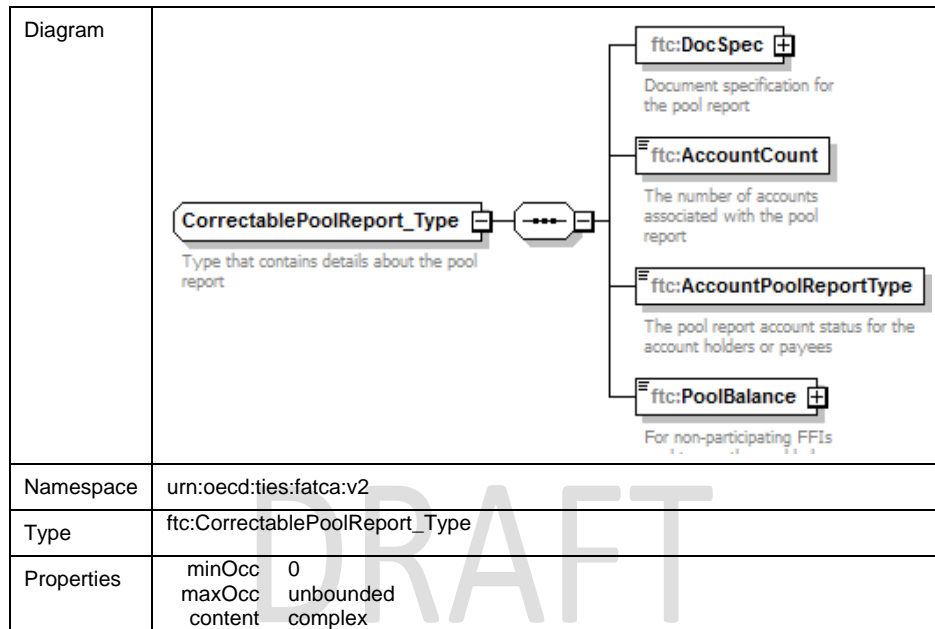

Table 25 - Pool Report

6.5.1 DocSpec

Element	Attribute	Size	Data Type	Schema Requirement	Application Requirement
DocSpec			sfa:DocSpec_Type	Required	

This data element is described in [Section 4.2. DocSpec](#).

6.5.2 AccountCount - Update

Element	Attribute	Size	Data Type	Schema Requirement	Application Requirement
AccountCount			xsd:positiveinteger	Required	

This data element specifies the total number of accounts reported for pooled reports. For example, if there are 25 accounts described in the pooled report, then enter "25".

6.5.3 AccountPoolReportType - Updated

Element	Attribute	Size	Data Type	Schema Requirement	Application Requirement
AccountPoolReportType			ftc:FatcaAcctPoolReportType_EnumType	Required	

This data element describes pooled reporting account type categories for account holders.

Account Pool Report Types:

Values	Description
FATCA201	Recalcitrant account holders with US indicia
FATCA202	Recalcitrant account holders without US indicia
FATCA203	Dormant accounts
FATCA204	Nonparticipating foreign financial institutions (2015 and 2016)
FATCA205	Recalcitrant account holders that are US persons
FATCA206	Recalcitrant account holders that are passive NFFE

6.5.4 PoolBalance

DRAFT

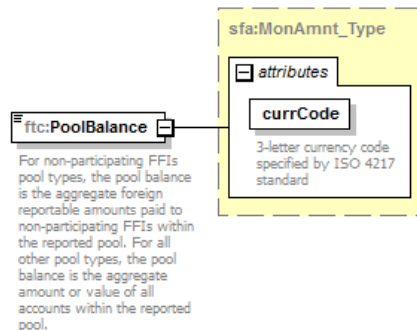

Figure 17 - PoolBalance element

Element	Attribute	Size	Data Type	Schema Requirement	Application Requirement
PoolBalance			sfa:MonAmnt_Type	Required	

This data element provides the amount of the aggregate balance or value for the pooled accounts, other than a pool of nonparticipating FFIs, at the end of the year.

For a pool of nonparticipating FFIs, enter, as the pool balance, the aggregate foreign reportable amounts paid to all nonparticipating FFIs within the reported pool. Instead of reporting foreign reportable amounts, the FI may report all income, gross proceeds, and redemptions (irrespective of source) paid to all nonparticipating FFIs. The data type is described in [Section 4.1. MonAmnt_Type](#).

7 Correcting, Amending and Voiding Records - New

During the year, a filer may change data reported in one or more records of a previously filed FATCA Report, such as a Nil Report, Account Report and/or Pool Report. To facilitate accurate error handling, the XML schema contains correctable data types that allow you to update a specific part of the report without resending the entire report. This section explains how to resubmit corrected, voided or amended data that can be processed and associated with the original data.

The DocSpec data element identifies a specific correctable element in the message and each correctable data type, such as CorrectableAccountReport_Type or CorrectablePoolReport_Type, contains a DocSpec element. This structured element ensures all updates can be traced to a previous record. The DocSpec_Type is described in [Section 4.2. DocSpec](#).

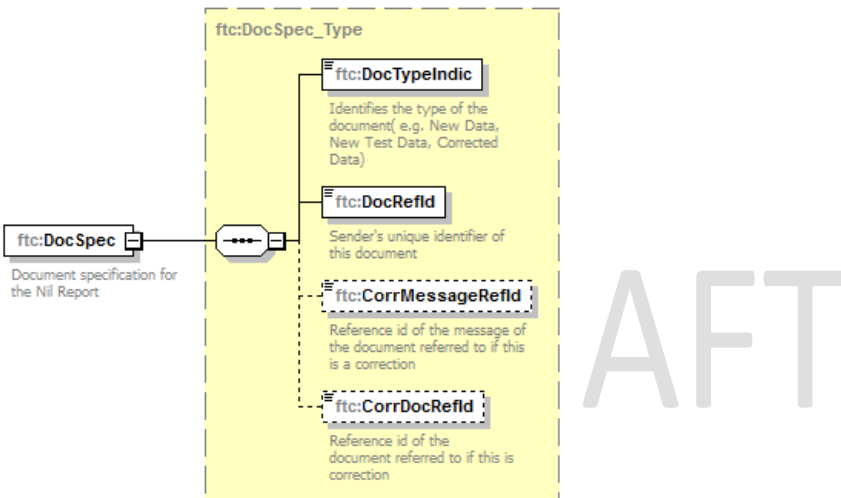

Figure 18 - DocSpec element

Note: These guidelines only apply to electronically filed reports. If the Form 8966 was filed in paper format with the IRS, then the corrected Form 8966 must also be filed in paper format with the IRS. Failure to follow this rule will result in your corrected Form 8966 not being processed by the IRS. The process of correcting, amending and voiding a report filed in paper format is in the Instructions for Form 8966.

7.1 Unique MessageRefId and DocRefId

The DocSpec contains a MessageRefId and DocRefId that uniquely identify correctable elements and messages. Each identifier must conform to recommended best practices for file format and remain unique across all reports for all time. Any duplicate identifiers will cause an error notification and cannot be reused within the scope of FATCA reporting.

7.2 How to Correct, Amend or Void Records

There are a few factors to consider when updating a record. Generally, there are three levels of validation (schema level, file-level and record-level) and a data file must be accepted by the IRS before any changes can be presented. If a file is not accepted (rejected) or fails transmission, a new file should be submitted because failed transmissions are not processed. This section explains guidelines on how to void, amend and correct a record. For more information on error notifications, go to [Section 1.4 Purpose](#).

What is a record?

A record consists of filer information, such as ReportingFI and Sponsor or Intermediary (if any), plus a Nil Report or AccountReport and/or PoolReport.

It is important to note that filer information for a ReportingFI, Sponsor or Intermediary (if any) cannot be corrected, voided, or amended alone; only a whole record can be changed.

For example:

- If you change filer information for a Reporting FI (CompanyIGA2), plus specific record information (Record1), the update only applies to that specific record (Record1). The updated filer information does not apply to other records that contained the same ReportingFI (CompanyIGA2).
- If you void a record (Record2) and another record (Record3) contains the same Reporting FI, you are only voiding that specific record (Record2). It does not apply to the same ReportingFI, associated with another record (Record3).

What are failed transmissions and error notifications?

Each record has a unique identifier associated with filer information. Generally, a transmission may fail transmission because of various file level integrity errors, such as decryption, digital signatures or virus scanning. If a transmission fails file level validation, the processing is not completed and you will receive an error notification. In most cases, the user must correct the error and resubmit the file. After the IRS accepts the file, you can only make changes at the record level.

What are the differences between corrected, voided and amended records?

After the IRS accepts a file and sends a valid file notification, each file and record are validated against the schema and business requirements. Generally, there are three scenarios for updating a previously filed FATCA Report:

- **Void:** If you discover a record was sent in error and were not required to file, then you can void the record.
- **Amend:** If you discover a record should be updated and have not received a record level error notification, you can amend record. In some special cases, as described below, you must void and send a new record.
- **Correction:** If you receive a record-level error notification because the record failed schema or business validation, you should correct the record. Some exceptions may apply.

7.2.1 Amend

A record may be amended at any time after you receive a valid notification. An amended record updates an existing record from a previously filed report.

- All data element fields in the amended record must have the amended values for the relevant account and/or pooled report.
- Do not amend a record in response to a record-level error notification; instead file a corrected record with DocTypeIndic FATCA2.
- Special rules for specific errors or changes may apply.

7.2.2 Void

A record may be voided at any time after you receive a notification and become aware of inaccurate information.

- All data element fields in the voided record must have the same values equal to the original record being voided.
- In most cases, do not void a record in response to a record-level error notification
- Special rules apply for specific error notifications that require you to void the record (DocTypeIndic FATCA3) and submit a new record with DocTypeIndic FATCA1.

7.2.3 Correct

A record should be corrected in response to a record-level error notification.

- All data element fields in the corrected record must have the corrected values for the relevant account and/or pooled report, as noted in the error notification.
- As noted below in **Special Cases for Amendment and Corrections**, special rules apply for specific error notifications that require you to void the record and submit a new record.
 - For example, you receive a record level error notification for Element A and you also discover an update to Element B, you can send an amended record with a correction.
 - For example, you receive a record-level notification for a Record4, but then discover you were not required to file the record. You can void this record instead of correction.

7.2.4 Special Cases to Amend and Correct Records

The following fields cannot be corrected or amended. You must void the record and submit a new record if there is an error in the field.

- No Account Holder or Substantial US Owner TIN
- Incorrect Account Holder or Substantial US Owner TIN
- Incorrect Account Holder or Substantial US Owner Name
- Incorrect Account Holder or Substantial US Owner Name and Address

In addition, for certain IGA jurisdictions the following errors would result in a voided record:

- No Individual Account Holder or Substantial US Owner TIN OR Date of Birth
- No Individual Account Holder or Substantial US Owner TIN and Incorrect Date of Birth

Note: For more information on IRS error notifications and resolutions, go to <https://www.irs.gov/businesses/corporations/irs-fatca-report-notifications>.

7.3 MessageSpec and DocSpec

This section provides general guidelines on how to complete the data elements when creating a file to correct, amend or void a record. All changes in these fields must be made within the MessageSpec and DocSpec data elements.

MessageSpec

A file contains a MessageSpec element or header that provides information about the sender and specifies the date created, calendar year and reporting period.

Element	Description
MessageRefId	Create a new unique value for the message
CorrMessageRefId	<p>List one or many CorrMessageRefIds and each must be set to the value of the MessageRefId in the file that contained a record to be voided, amended or corrected.</p> <p>If sending a corrected file, the original MessageRefId can be found in the notification.</p> <p>Example:</p> <pre><CorrMessageRefId>OrigMessageRefId1<CorrMessageRefId> <CorrMessageRefId>OrigMessageRefId2<CorrMessageRefId> <CorrMessageRefId>OrigMessageRefId3<CorrMessageRefId></pre>

DocSpec

The DocSpec uniquely identifies a data element and references the record being corrected, amended or voided.

Element	Description
DocTypeIndic	<p>Enter one of the following:</p> <p>FATCA2 (Correct), FATCA3 (Void) or FATCA4 (Amend) to specify a change to each record.</p> <p>As a best practice, the file should contain only one data type. Do not combine data types into one file or send a FATCA2, 3 and/or 4 in the same message.</p> <p>Note: Many corrections from different messages can be combined into one file, but do not combine voided, corrected and amended records into one file.</p>
DocRefId	Create a new unique value using format described in Section 4.2.2. DocRefId .

CorrMessageRefId	Enter the value of the MessageRefId in the file that contained a record that you are voiding, amending or correcting.
CorrDocRefId	Enter the value of the DocRefId of the element in the record you are correcting, voiding or amending.

Note: For testing purposes only, use the applicable DocTypeIndic for test data, such as FATCA12, FATCA13 or FATCA14. Do not send test data to the production environment or production files to the test environment. For more information on testing, go to [Section.2.7. System Testing](#).

Note: Sample files on how to correct, amend or void a record can be found at <https://www.irs.gov/businesses/corporations/fatca-xml-reporting-schema-samples-to-correct-amend-or-void-records>.

DRAFT

Appendix A: Glossary of Terms

Terms	Definition
Account holder	An account holder is the person who holds a financial account, as determined under Regulations section 1.1471-5(a)(3).
Branch	A branch means a unit, business, or office of an FFI that is treated as a branch under the regulatory regime of a country or that is otherwise regulated under the laws of a country as separate from other offices, units, or branches of the FFI, and includes a disregarded entity of an FFI. A branch includes units, businesses, and offices of an FFI located in the country (or jurisdiction) in which the FFI is a resident as well as units, businesses, and offices of an FFI located in the country in which the FFI is created or organized. All units, businesses, or offices of a PFFI located in a single country (or jurisdiction), including all disregarded entities located in such single country (or jurisdiction), must be treated as a single branch.
Branch that maintains an account	A branch, including a disregarded entity, maintains an account if the rights and obligations of the account holder and the FFI with regard to such account (including any assets held in the account) are governed by the laws of the country of the branch or disregarded entity.
Deemed-compliant FFI	A deemed-compliant FFI means an FFI that is treated, pursuant to section 1471(b)(2) and Regulations section 1.1471-5(f), as meeting the requirements of section 1471(b).
Direct Reporting NFFE	A direct reporting NFFE is a non-financial foreign entity (NFFE) that has elected to report its substantial U.S. owners to the IRS pursuant to Treas. Reg. section 1.1472-1(c)(3).
Employer Identification Number (EIN)	A number used by the IRS to identify a business entity. It is also known as a Federal Tax Identification Number.
Excepted NFFEs	Excepted NFFEs include NFFEs that are QIs, WPs, and WTs, certain publicly traded corporations (including certain affiliates of such corporations), certain territory entities, active NFFEs, excepted nonfinancial entities, Direct Reporting NFFEs, and Sponsored Direct Reporting NFFEs as described in Regulations section 1.1472-1(c)(1).
Financial Institution (FI)	A financial institution is any institution that is a depository institution, custodial institution, investment entity, insurance company (or holding company of an insurance company) that issues cash value insurance or annuity contracts, or a holding company or treasury center that is part of an expanded affiliated group of certain FFIs, and includes a financial institution as defined under an applicable Model 1 IGA or Model 2 IGA. See Regulations section 1.1471-5(e)(1).
Foreign Financial Institution (FFI)	A foreign financial institution means a financial institution that is a foreign entity. The term foreign financial institution also includes a foreign branch of a U.S. financial institution with a QI Agreement in effect.

Term	Definition
Global Intermediary Identification Number (GIIN)	A global intermediary identification number or GIIN means a number assigned to a PFFI, Reporting Model 1 FFI, Reporting Model 2 FFI, RDC FFI, and certain other registering entities (e.g., a Direct Reporting NFFE). A separate GIIN will be issued to the FFI to identify, among other things, each jurisdiction where the FFI maintains a branch not treated as a limited branch. A Direct Reporting NFFE will be issued only one GIIN, irrespective of where it maintains branches.
Intergovernmental Agreement (IGA)	An agreement or arrangement between the U.S. or the Treasury Department and a foreign government or one or more agencies to implement FATCA.
Model 1 IGA (HCTA)	A Model 1 IGA means an agreement between the United States or the Treasury Department and a foreign government or one or more foreign agencies to implement FATCA through reporting by financial institutions to such foreign government or agency thereof, followed by automatic exchange of the reported information with the IRS.
Model 2 IGA	A Model 2 IGA means an agreement or arrangement between the United States or the Treasury Department and a foreign government or one or more foreign agencies to implement FATCA through reporting by financial institutions directly to the IRS in accordance with the requirements of the FFI agreement, as modified by an applicable Model 2 IGA, supplemented by the exchange of information between such foreign government or agency thereof and the IRS.
Non-financial foreign entity (NFFE)	A non-financial foreign entity (NFFE) is a foreign entity that is not a financial institution. An NFFE includes a territory NFFE as defined in Regulations section 1.1471-1(b)(132) and a foreign entity treated as an NFFE pursuant to a Model 1 IGA or Model 2 IGA.
Participating Financial Institution (PFFI)	A PFFI is an FFI, or branch of an FFI, that has in effect an FFI agreement with the IRS, and includes a Reporting Model 2 FFI.
Qualified Intermediary (QI), Withholding Foreign Partnership (WP), Withholding Foreign Trust (WT)	A QI is a foreign entity (or foreign branch of a U.S. financial institution) that has entered into a QI agreement with the IRS. A WP is a foreign partnership that has entered into a withholding foreign partnership agreement with the IRS. A WT is a foreign trust that has entered into a withholding foreign trust agreement with the IRS.
Registered deemed-compliant FFI (RDC FFI)	A registered deemed-compliant FFI is an FFI described in Regulations section 1.1471-5(f)(1), and includes a Reporting Model 1 FFI, a QI branch of a U.S. financial institution that is a Reporting Model 1 FFI, and a nonreporting FI treated as a registered deemed-compliant FFI under a Model 2 IGA.
Reporting FI under a Model 1 or Model 2 IGA	An FI that is treated as a reporting FI under the terms of a Model 1 or Model 2 IGA that is in effect. The term reporting FI also includes a foreign branch of a USFI that is treated as a reporting FI under the terms of a Model 1 IGA that is treated as in effect. A foreign branch of a USFI treated as a reporting FI under the terms of a Model 2 IGA is not required to submit a FATCA Registration form to obtain a GIIN, unless it is renewing a QI Agreement.

Term	Definition
Sponsored Direct Reporting NFFE	A Sponsored Direct Reporting NFFE is a Direct Reporting NFFE that has a Sponsoring Entity perform due diligence and reporting requirements on behalf of the Sponsored Direct Reporting NFFE as described in Regulations section 1.1472-1(c)(5).
Sponsored Direct Reporting NFFE	A direct reporting NFFE that has another entity, other than a nonparticipating FFI, that agrees to act as its sponsoring entity.
Sponsoring Entity	A Sponsoring Entity is an entity that has registered with the IRS to perform the due diligence, withholding, and reporting obligations of one or more Sponsored FFIs or Sponsored Direct Reporting NFFEs.
Substantial U.S. owner	A substantial U.S. owner is a specified U.S. person described in Regulations section 1.1473-1(b). For purposes of filing this form, a Reporting Model 2 FFI reporting an account held by a passive NFFE should substitute the term “controlling person that is a specified U.S. person” for “substantial U.S. owner” and refer to the applicable Model 2 IGA for the definition of controlling U.S. person. A territory NFFE that is not an excepted NFFE determines its substantial U.S. owners by applying the 10 percent threshold in Regulations section 1.1473-1(b)(1).
Territory Financial Institution	A Territory Financial Institution is a financial institution that is incorporated or organized under the laws of any U.S. territory, excluding a territory entity that is a financial institution only because it is an investment entity.
Territory Financial Institution treated as a U.S. person	A Territory Financial Institution treated as a U.S. person means a Territory Financial Institution treated as a U.S. person under Regulations section 1.1471-3(a)(3)(iv).
Trustee-Documented Trust	A trust described as such in a Model 1 IGA or a Model 2 IGA.
Withholdable payment	A withholdable payment is a payment described in Regulations section 1.1473-1(a).

Table 26 - Glossary of terms

Appendix B: FATCA XML Schema Overview

PENDING UPDATE

DRAFT

Appendix C: MessageSpec

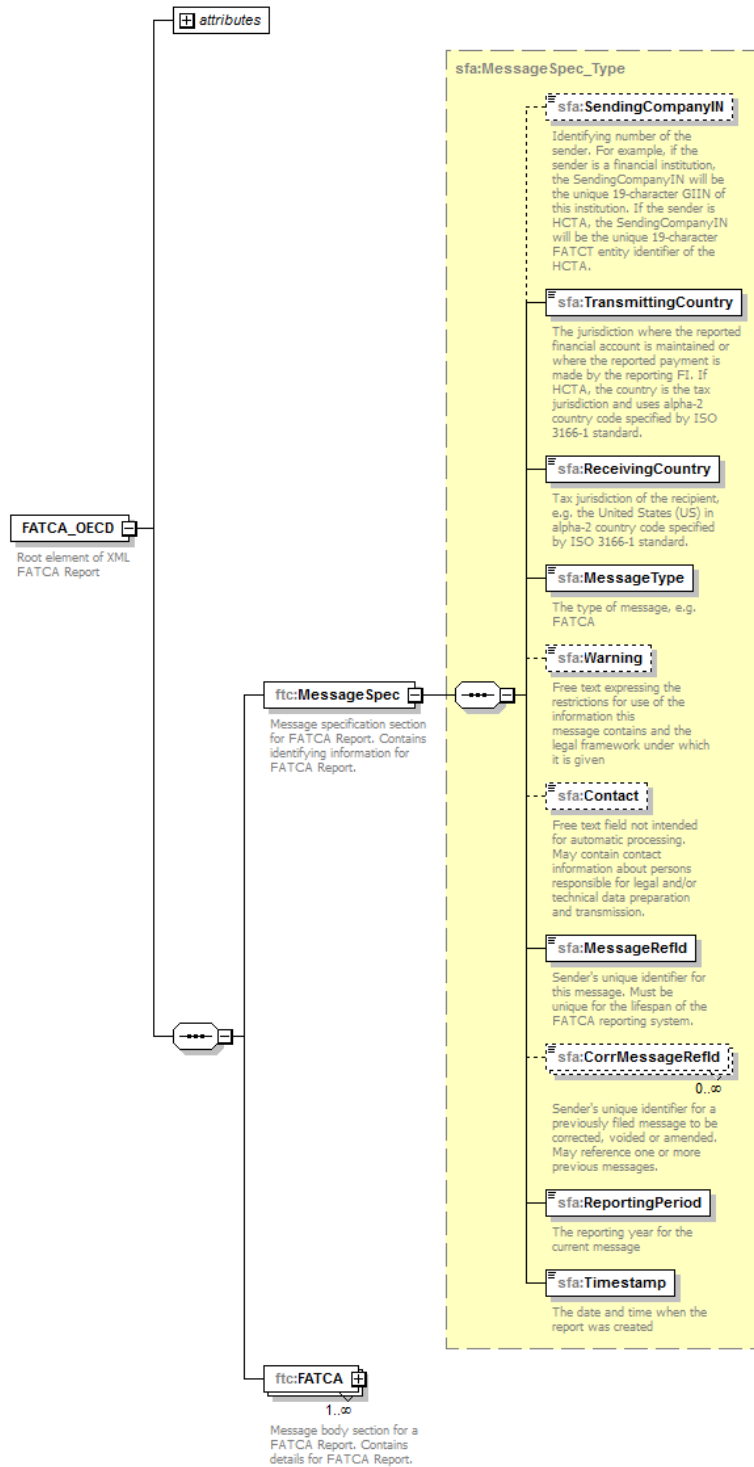

Appendix D: Reporting FI

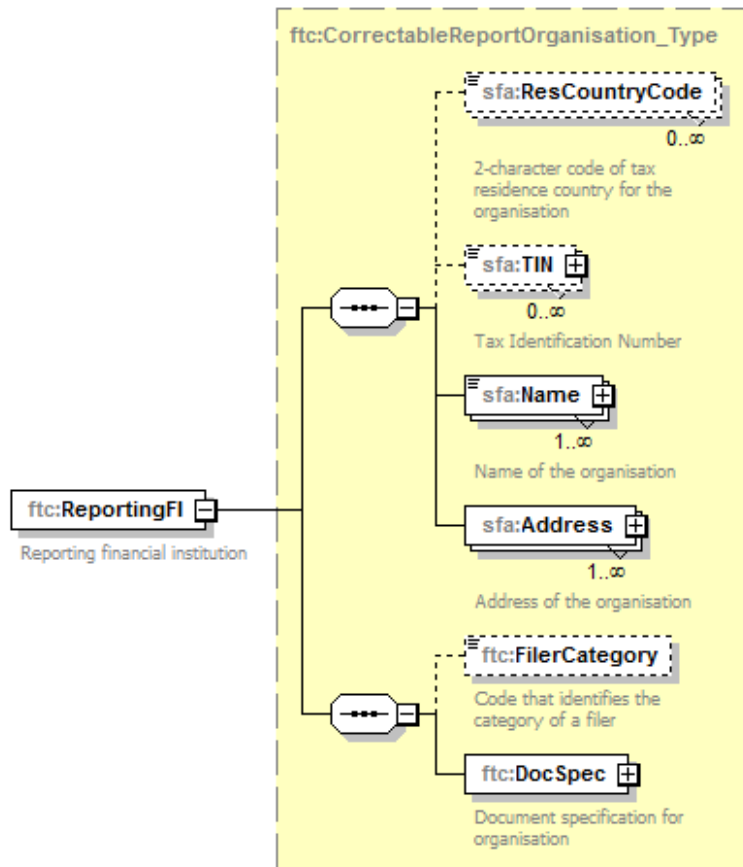

Appendix E: Reporting Group

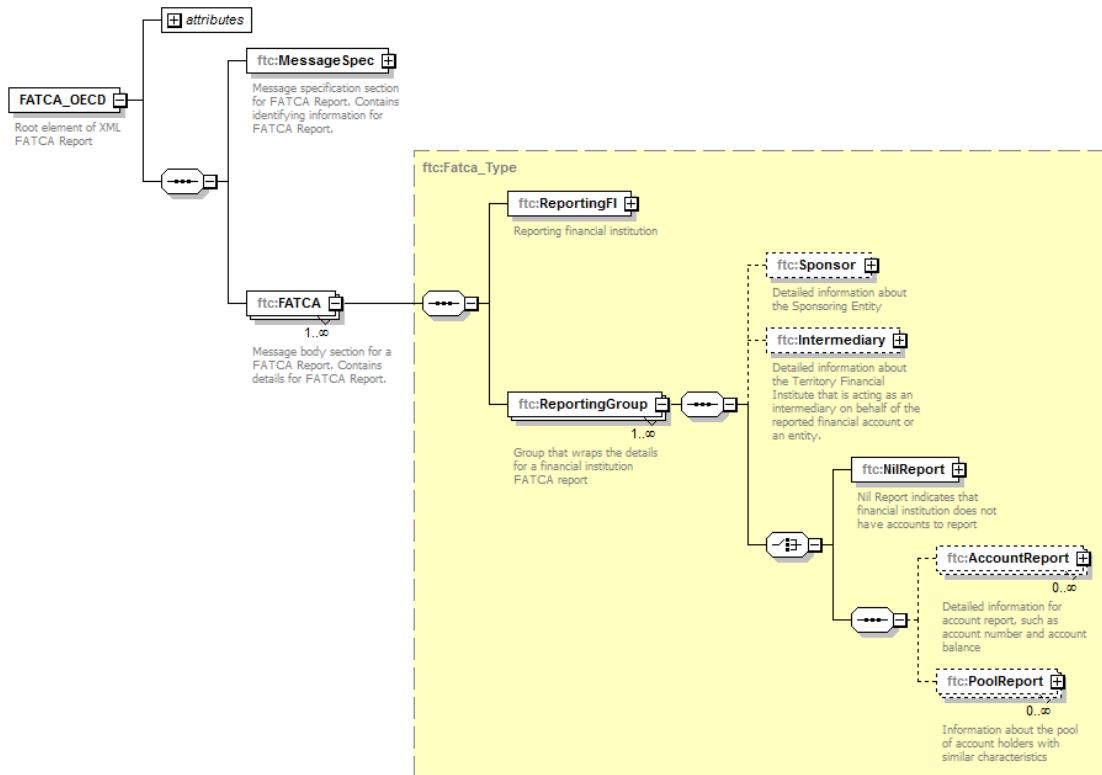

Appendix F: Account Report

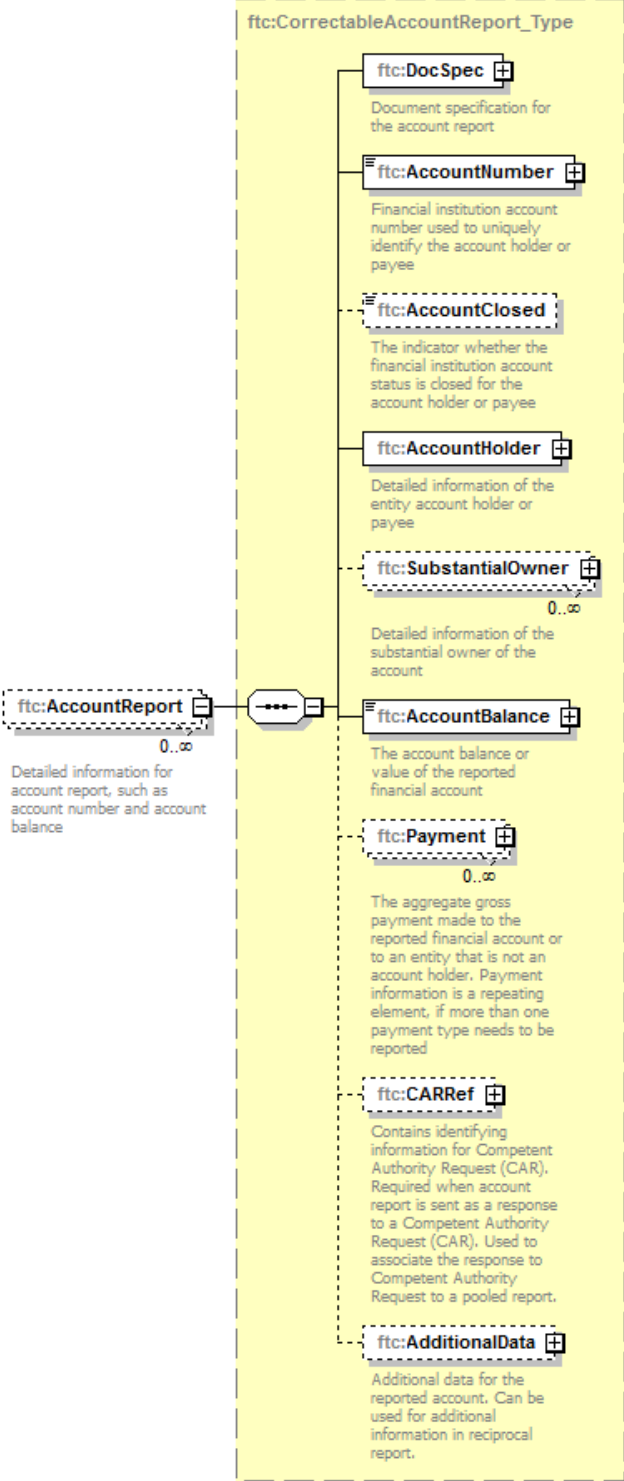

Appendix G: Pool Report

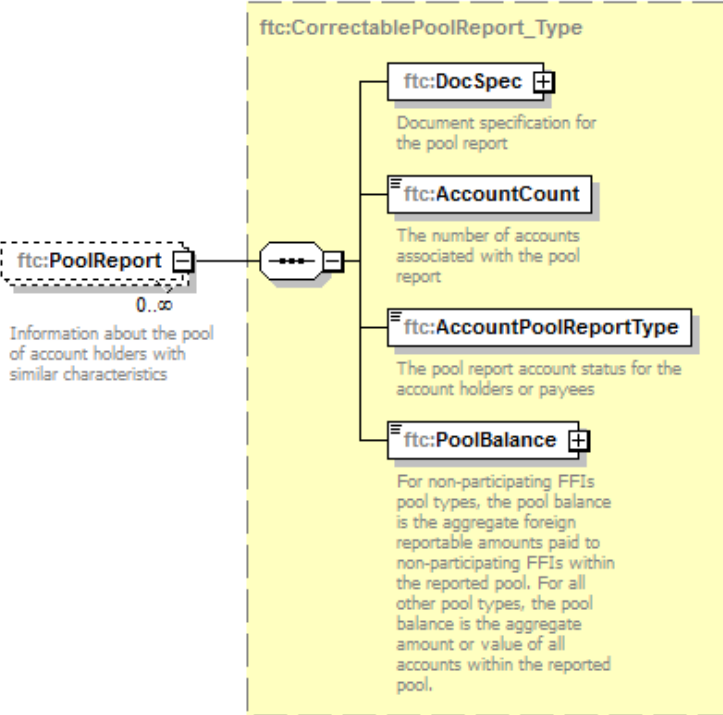

Appendix H: Account Holder

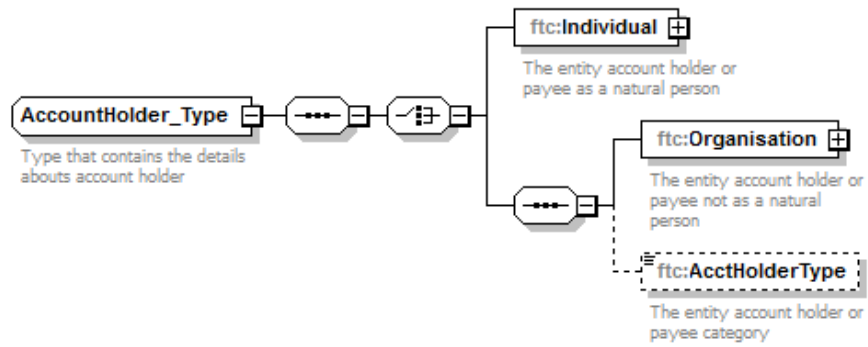

Appendix I: Substantial Owner

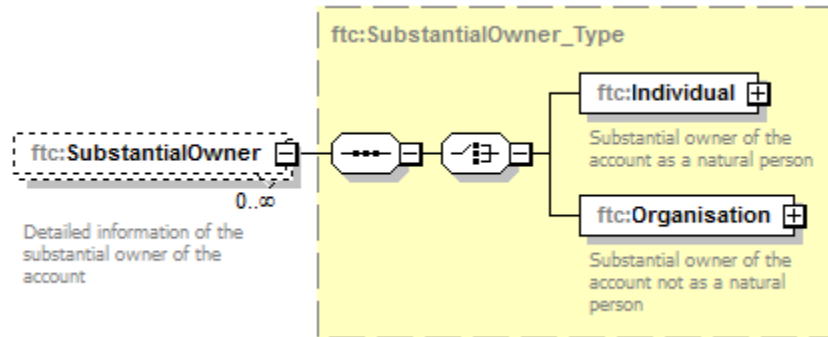

Appendix J: Sponsor & Intermediary

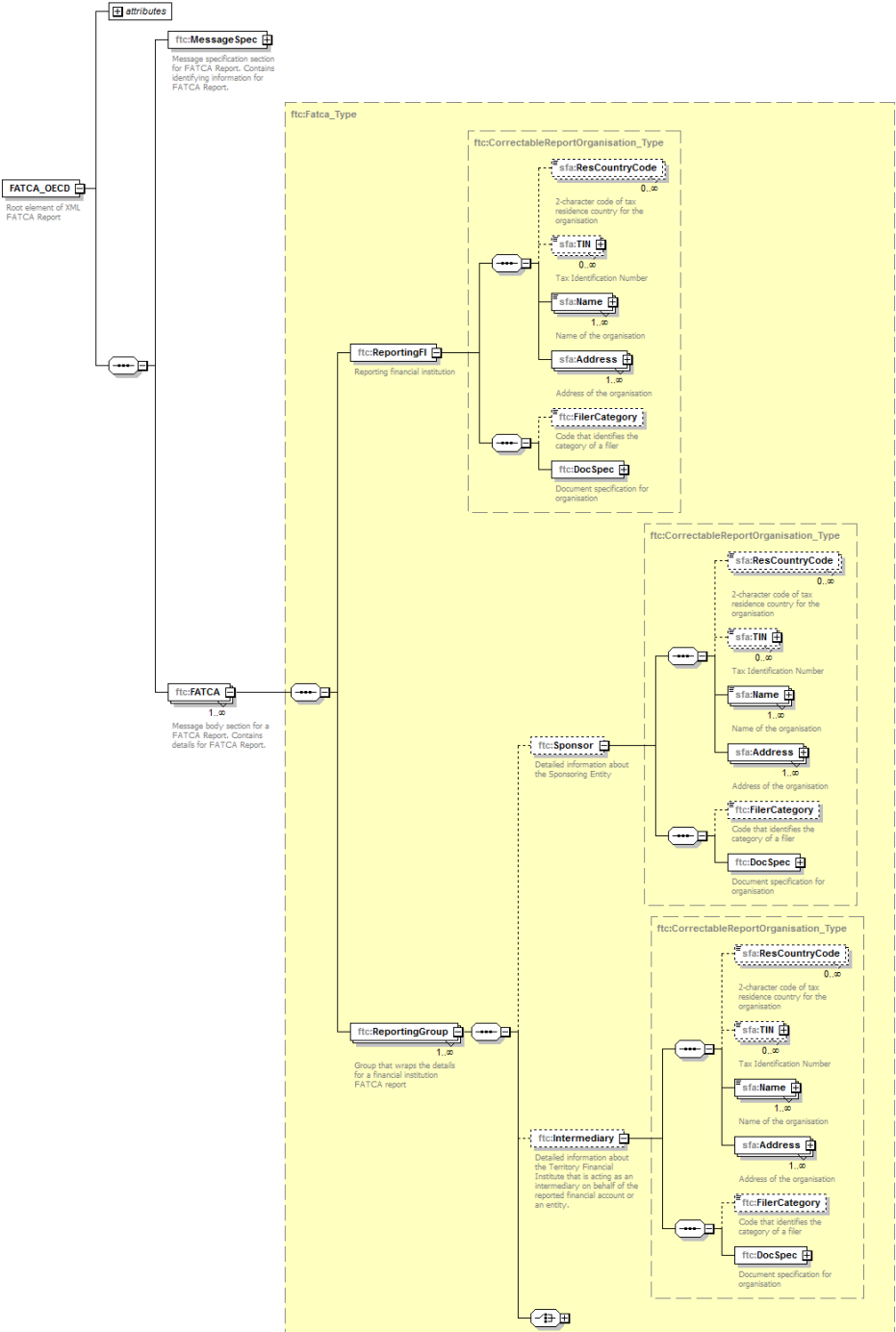

Generated by XMLSpy www.altova.com

Appendix K: Individual or Organization Account Holders

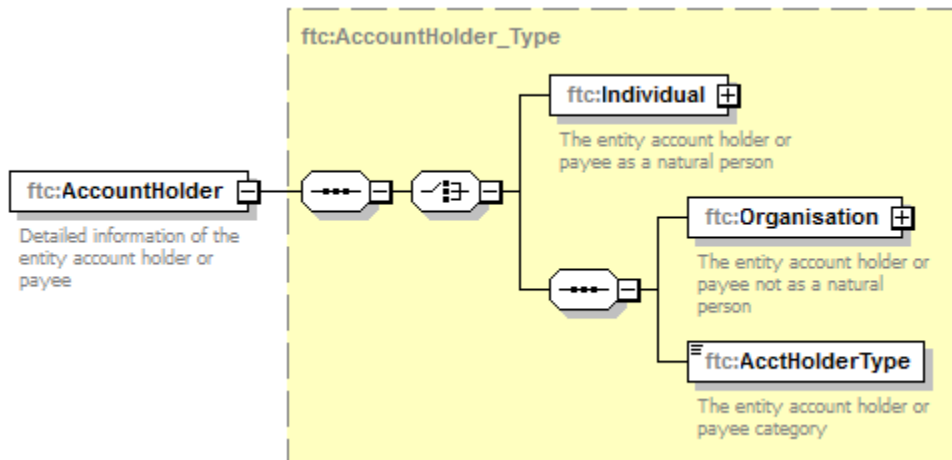

Appendix L: Person Party Type

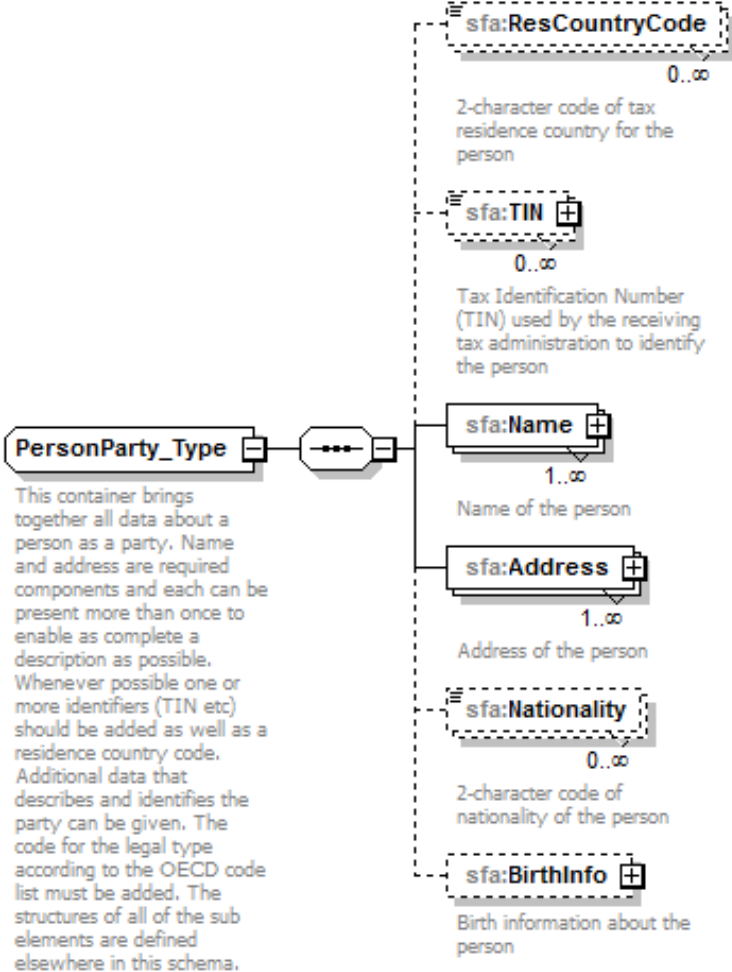

Appendix M: Address Type

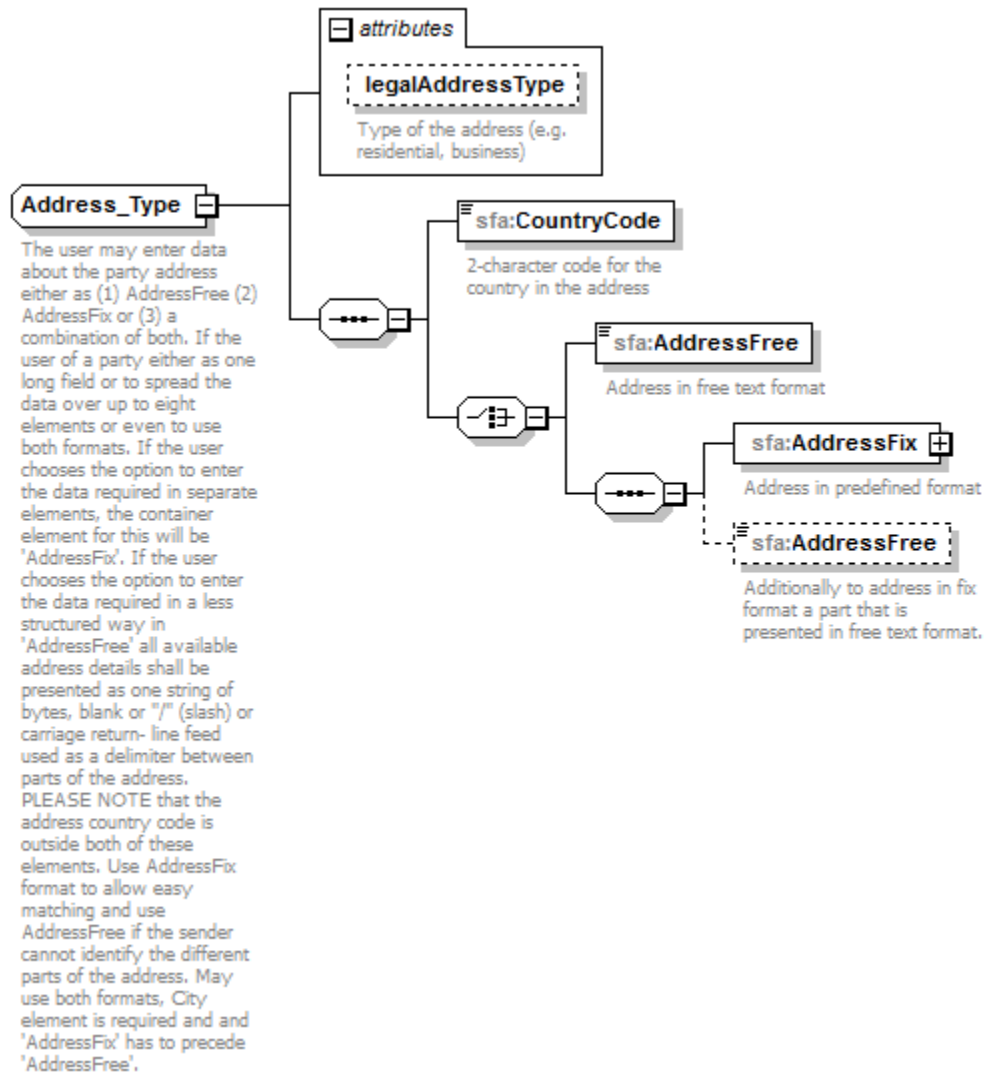

Appendix N: OrganisationParty_Type

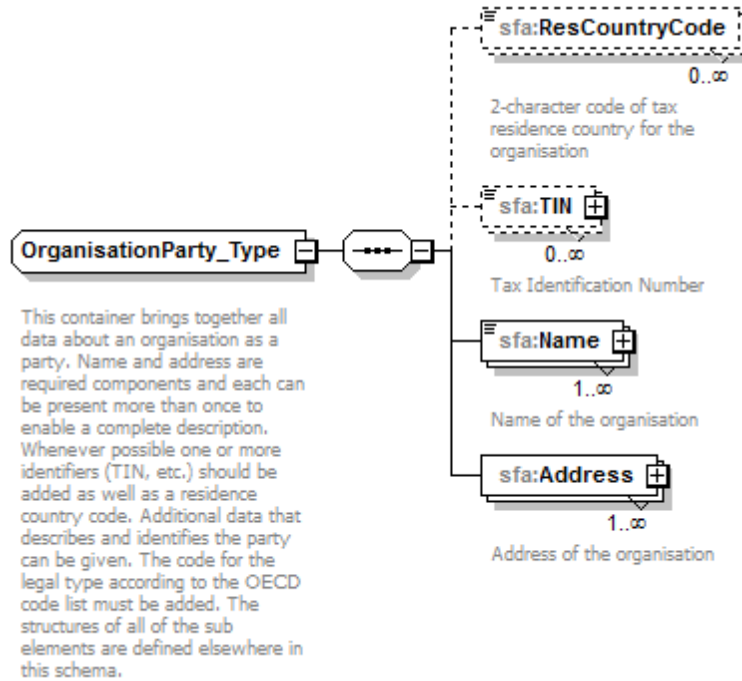

Appendix O: CorrectableReportOrganisationParty_Type

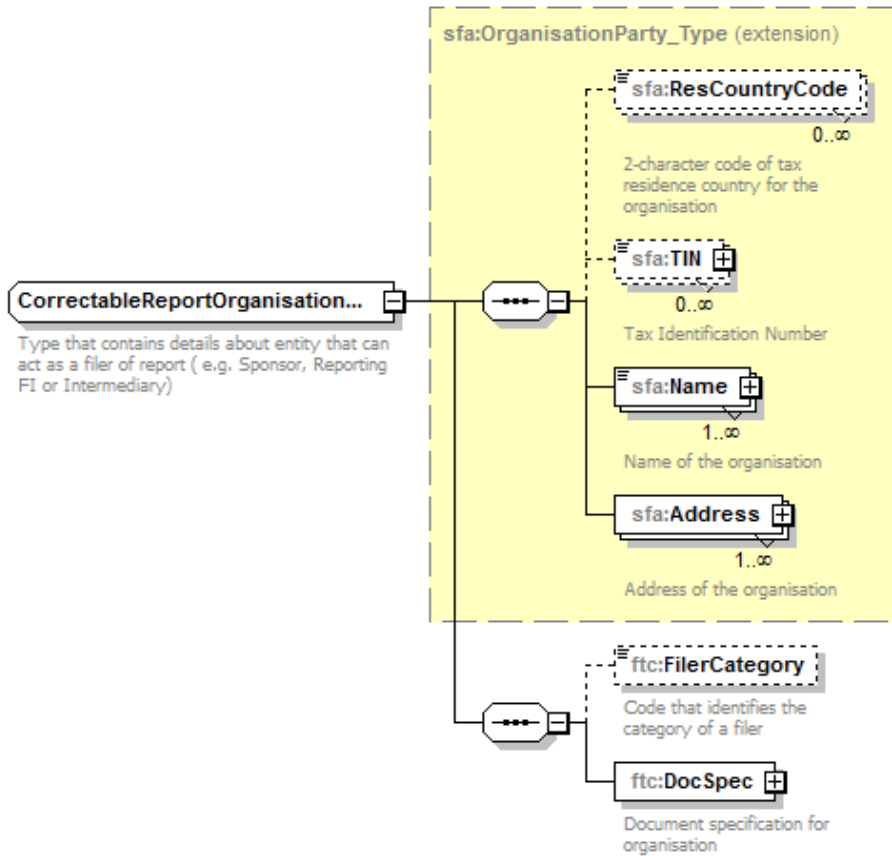

Appendix P: DocSpec_Type

